

TEAC Tascam Series

Model 144

PORTASTUDIO™ T.M.

Owner's Reference Manual



TABLE OF CONTENTS

1	FRONT & REAR PANEL FEATURES
6	SECTION 1 INTRODUCTION
7	SECTION 2 RECORDING THE FIRST TRACK
9	SECTION 3 OVERDUBBING
11	SECTION 4 REMIXING
13	SECTION 5 PING PONG (COMBINING TWO OR THREE TRACKS TO ONE)
14	SECTION 6 STEREO/2-TRACK TRANSFERS
15	SECTION 7 STEREO/2-TRACK RECORDING
18	SECTION 8 AUXILIARY SIGNAL PROCESSING
20	SECTION 9 PUNCH-IN RECORDING DURING AN OVERDUB
21	SECTION 10 AN ALTERNATIVE CUE SYSTEM – USE ONE BUSS (L OR R)
22	SECTION 11 MIC PLACEMENT – SELECTION VS EQUALIZATION
23	SECTION 12 ABOUT IMPEDANCE AND LEVEL
25	SECTION 13 MAINTENANCE AND SERVICE
26	TROUBLESHOOTING CHART
28	BLOCK DIAGRAM
29	SECTION 14 SPECIFICATIONS

- Noise reduction circuit made under license from Dolby Laboratories. The word "Dolby" and the Double-D symbol are trademarks of Dolby Laboratories.

WARNING: TO PREVENT FIRE OR SHOCK HAZARD, DO NOT EXPOSE THIS APPLIANCE TO RAIN OR MOISTURE.

This unit has a Serial Number located on the rear panel. Please record the Model Number and Serial Number and retain them for your records.
Model Number _____
Serial Number _____

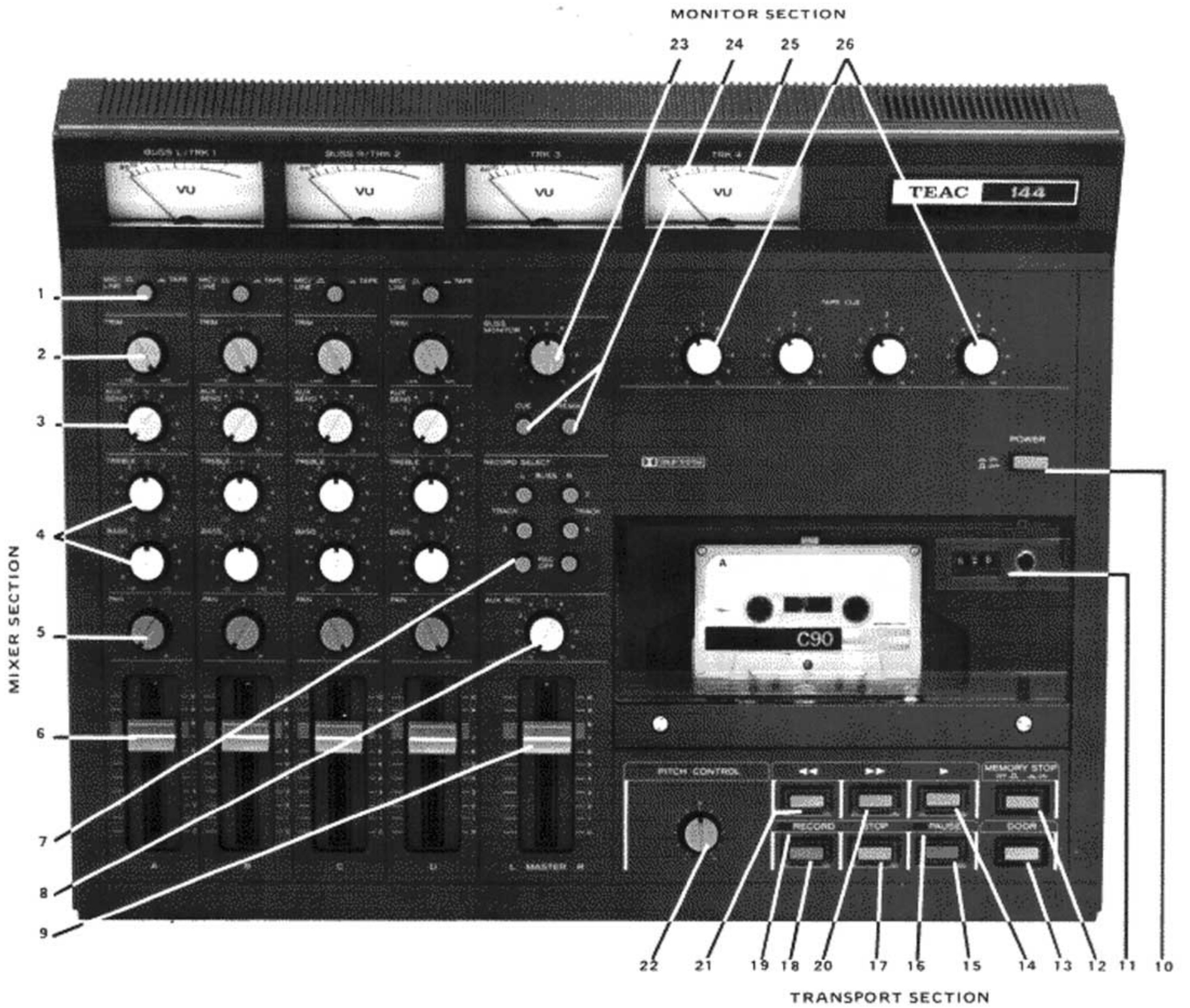

Figure 1 - Portastudio Front Panel

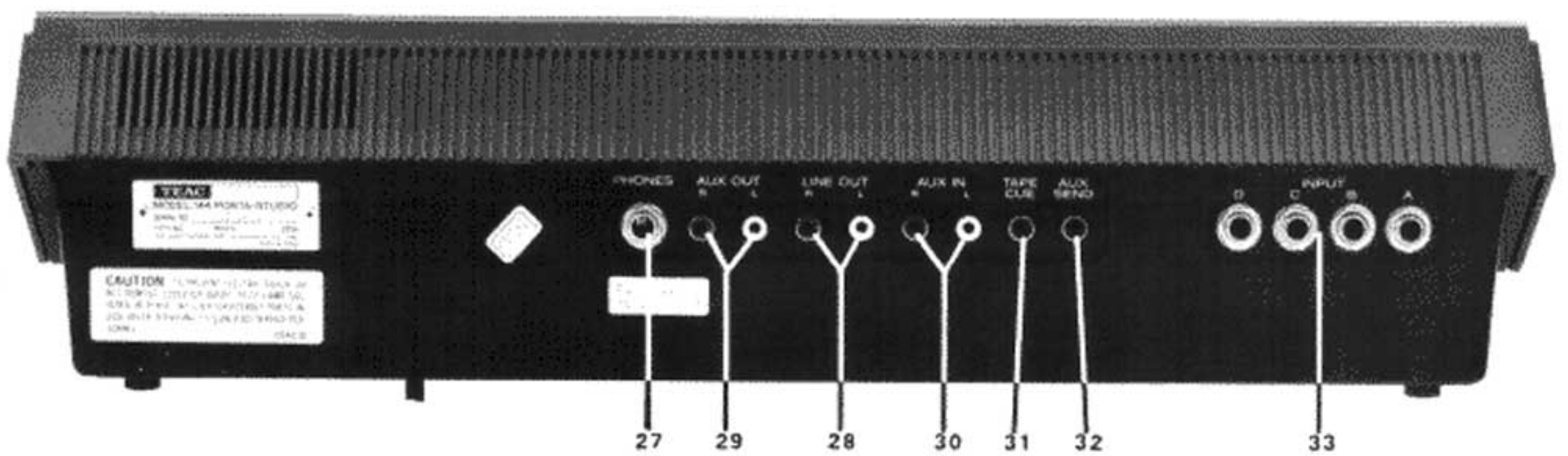

Figure 2 - Rear Panel

PORTASTUDIO FRONT PANEL FEATURES

Mixer Section

1. MIC/LINE-TAPE

In the up position this selects the Mic/Line connector as a source of signal. In the down position it selects tape playback from the built-in transport; input channel A now corresponds to tape Track 1, channel B to Track 2, channel C to Track 3 and channel D to Track 4.

2. TRIM

This control varies the amount of gain or amplification produced by the first amplifier. Although the trim control range is very wide (50 dB), it is possible that very high output line level sources may require external "pads," or gain lowering devices. When mic cable runs exceed 10 feet we strongly recommend the use of balanced (3-wire) microphones and mic input transformers (e.g. ME-120, ME-80, or MM-100 microphones with 109 series microphone transformers) to minimize interference that radios, television and citizens band transmitters may cause.

3. AUX SEND

This control feeds the input channel's post-fader, post-equalizer signal to a combining amplifier that mixes the Aux Sends of all four input channels for feed to the Aux Send jack. This mono mix may be used to feed external auxiliary signal processing equipment.

4. EQUALIZER

The Equalizer consists of one Bass and one Treble control. Turn the knobs clockwise to boost and counter-clockwise to cut. How much boost or cut? Here is a chart showing the maximum deviation from "flat". (See below)

5. PAN

This control is used to "route" a signal to either the Left Buss (Pan control fully Left), the Right Buss (Pan control fully Right) or to any point in between.

NOTE: Panning is generally used during remixing to position a signal anywhere from extreme Left to extreme Right in the stereo perspective, although it can be used for this same purpose when recording original tracks or overdubbing in stereo. When recording or overdubbing one track at a time, the Pan control is nearly always rotated fully Left or fully Right to assign the Left or Right Buss to a given track.

6. INPUT CHANNEL FADER

Controls the level of the signal selected from either the channel input jack or the playback from the Portastudio's built-in cassette recorder, depending on the setting of the Mic/Line-Tape switch.

7. RECORD SELECT SWITCH MATRIX

This group of switches performs two separate but related functions:

a. The Portastudio has only two Busses or mixing networks that can be used to record a maximum of two tracks at a time. The Left Buss assigns only to Track 1 or Track 3, so depressing both buttons serves no purpose. Only one Left program track will be recorded at a time. Should you force the buttons down together, the matrix will select Track 1 for recording. Similarly, the Right Buss assigns only to Track 2 or Track 4. The same logic applies; force down both buttons and you will get only Track 2; the top button has priority. The Rec Off buttons are used to clear or make the recorder "safe" so you don't accidentally erase a track that you wish to keep.

b. The switches also determine which VU meters are illuminated and what signal they display (i.e., either Track 1 through 4 playback level or Left and/or Right Buss level).

8. AUX RECEIVE

This control simultaneously sets the level of whatever inputs are plugged into the Left and Right Aux In jacks. The incoming aux signal is then applied directly to the Left and Right Busses just before the L-Master-R fader. Aux Receive is useful for returning echo or effects back into the program or for adding the output of an auxiliary mixer to the Portastudio.

9. L-MASTER-R FADER

This slide fader sets the overall program level for both the Left and Right Busses.

Transport Section

10. POWER

This pushbutton controls the main AC power for the entire Portastudio. Connect the unit to 120 Volt 60 Hz outlets only.

11. TAPE COUNTER

This 3-digit counter indicates

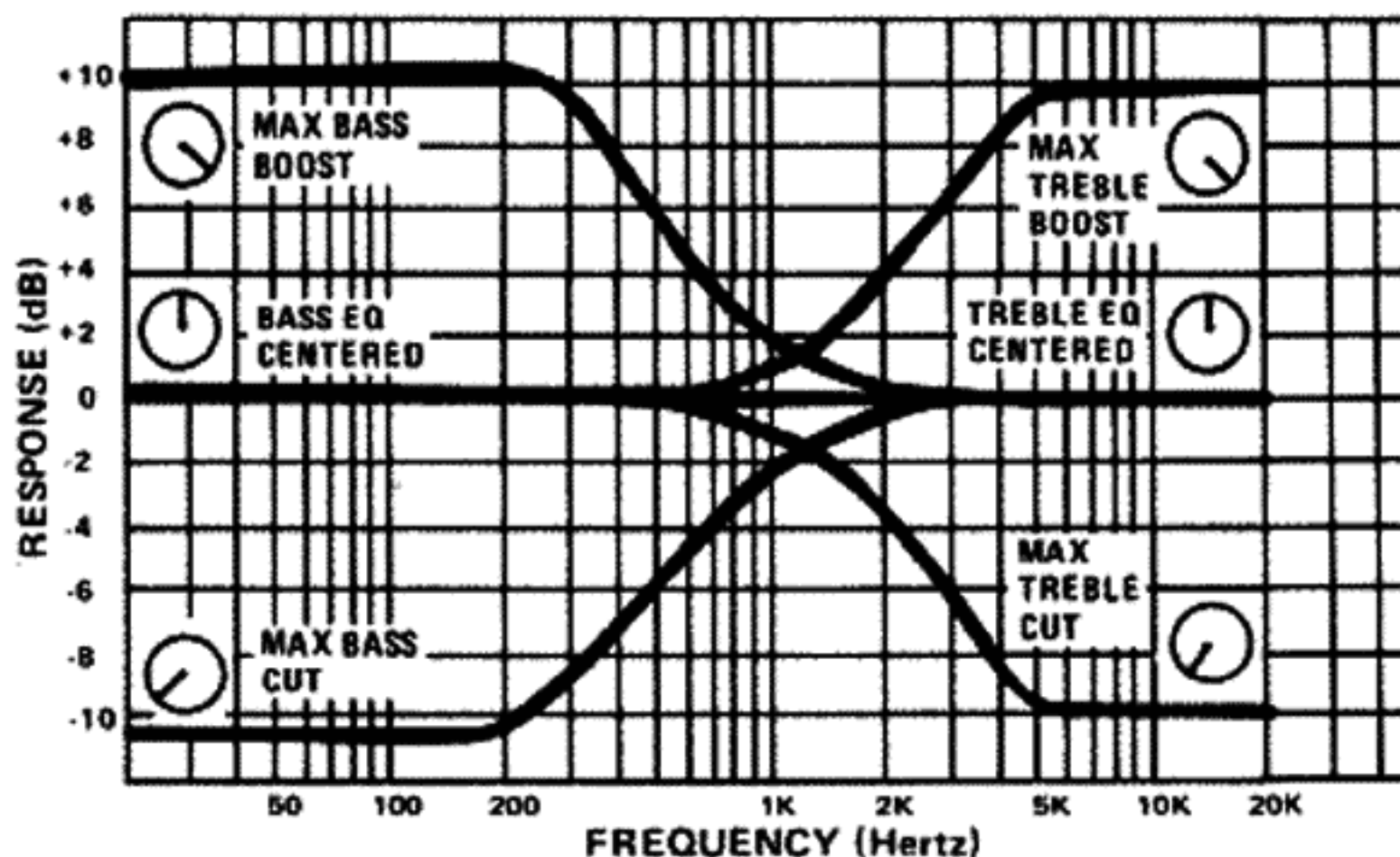

Figure 3 - Portastudio Equalizer Characteristics

how much tape has wound off the cassette supply hub. It can be zeroed at any point using the adjacent reset button.

12. MEMORY STOP

When in use (button down), this feature automatically stops tape rewinding at "000". This permits easy return to a particular section of the tape for overdubs, playback, etc.

13. DOOR

This button releases the latch on the cassette compartment door, which springs open to give access to the cassette. (Push a cassette straight down to insert it, and lift straight up to remove it.)

14. PLAY (▶)

Press this button to initiate *play* mode.

15. PAUSE

Press this button to temporarily halt playback or recording. If the unit is in *record* mode when you press Pause, pressing Play will resume recording.

16. PAUSE INDICATOR

This green light is ON when the unit is in *Pause* mode.

17. STOP

Pressing this button stops the tape transport and disables Play, Record or Pause modes.

18. RECORD

When depressed simultaneously with:

a. Pause, the system enters *Record Ready* mode. In this mode, recording will automatically begin on the Record Select-assigned tracks when the Play button is pushed.

b. Play, the system will automatically begin recording on the Record Select-assigned tracks.

19. RECORD INDICATOR

This light indicates whether the Portastudio is in *play* mode (light off), *record ready* mode (light flashing) or *record* mode (light On).

20. FAST FORWARD (▶▶)

21. FAST REWIND (◀◀)

These pushbuttons advance the tape at high speed in the indicated direction. The transport automa-

tically enters *stop* mode at the end of the cassette.

22. PITCH

This feature allows you to speed up or slow down the tape transport by up to 15%. Commonly found only on the most sophisticated equipment, it is useful for adjusting to pre-tuned instruments or previously recorded tracks.

NOTE: When Pitch is raised or lowered, performance of the built-in Dolby noise reduction circuitry may be affected.

Monitor Section

23. BUSS MONITOR

This control sets the level of the Left and Right Busses feeding the headphones. It does not affect the line outputs or aux outputs.

24. CUE & REMIX

What you will hear in the headphone circuit will be controlled by these 2 interlocking switches, as explained below:

a. When the Remix button is depressed you will hear the stereo output of the L + R Buss amplifiers. The levels you will hear are subject to the setting of the Buss/Monitor control. In this mode the Tape Cue controls do not have any affect on what you hear in the headphones.

b. With the Cue button down you will hear a mono combination of the L + R Buss Master

Signal, plus the signals controlled by the 4 Tape Cue controls, one for each track on the Portastudio recorder. These Tape Cue controls have signal available to them only *after* something has been recorded, so they cannot "double" as buss monitors in advance of playback. To hear them you must be in *Cue* (mono) mode.

25. VU METERS

These four illuminated meters display the playback level from Tracks 1 through 4 when both Rec Off switches are engaged. When any Record Select Track button is engaged, the first two meters display Left and Right Buss level; the only illuminated meter(s) now correspond to the selected Left and/or Right Buss. Meters 3 and 4 are illuminated only when both Rec Off switches are engaged (in playback mode).

See Record Select Matrix and VU Meter Operation diagrams below and on page 4.

26. TAPE CUE LEVEL CONTROLS

These 4 knobs, corresponding to Tracks 1 through 4, are used to create a mono mix of any existing tracks (already recorded tracks) during playback. The Tape Cue mix is always fed to the rear panel Tape Cue jack, but is also fed to the monitor system (Headphone jack) only when the Cue button is engaged.

Figure 4 - Record Select Matrix and VU Meter Operation

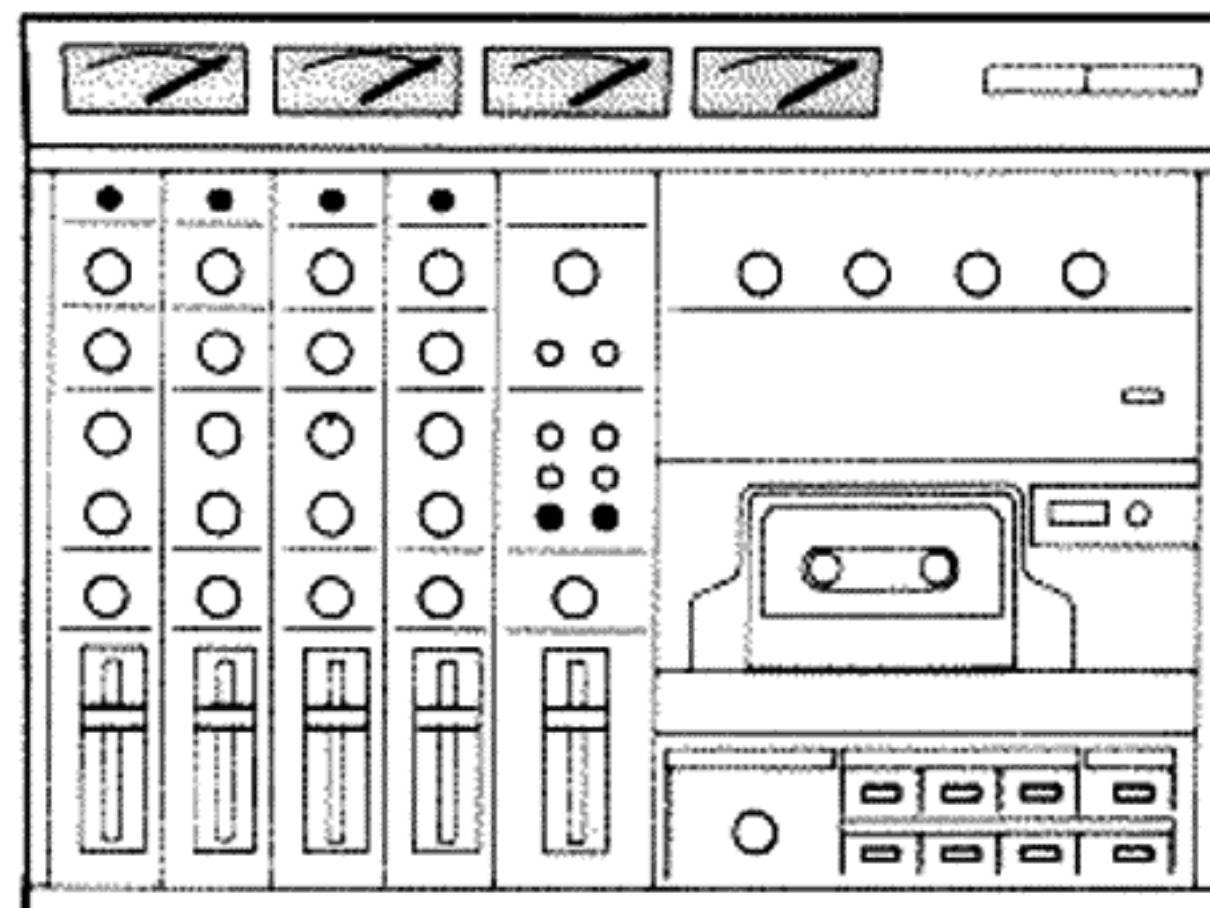

Four meters indicate playback levels of tracks 1-4. (When Input "Mic/Line-Tape" switches are down.)

Figure 4 continued next page.

Figure 4 continued.

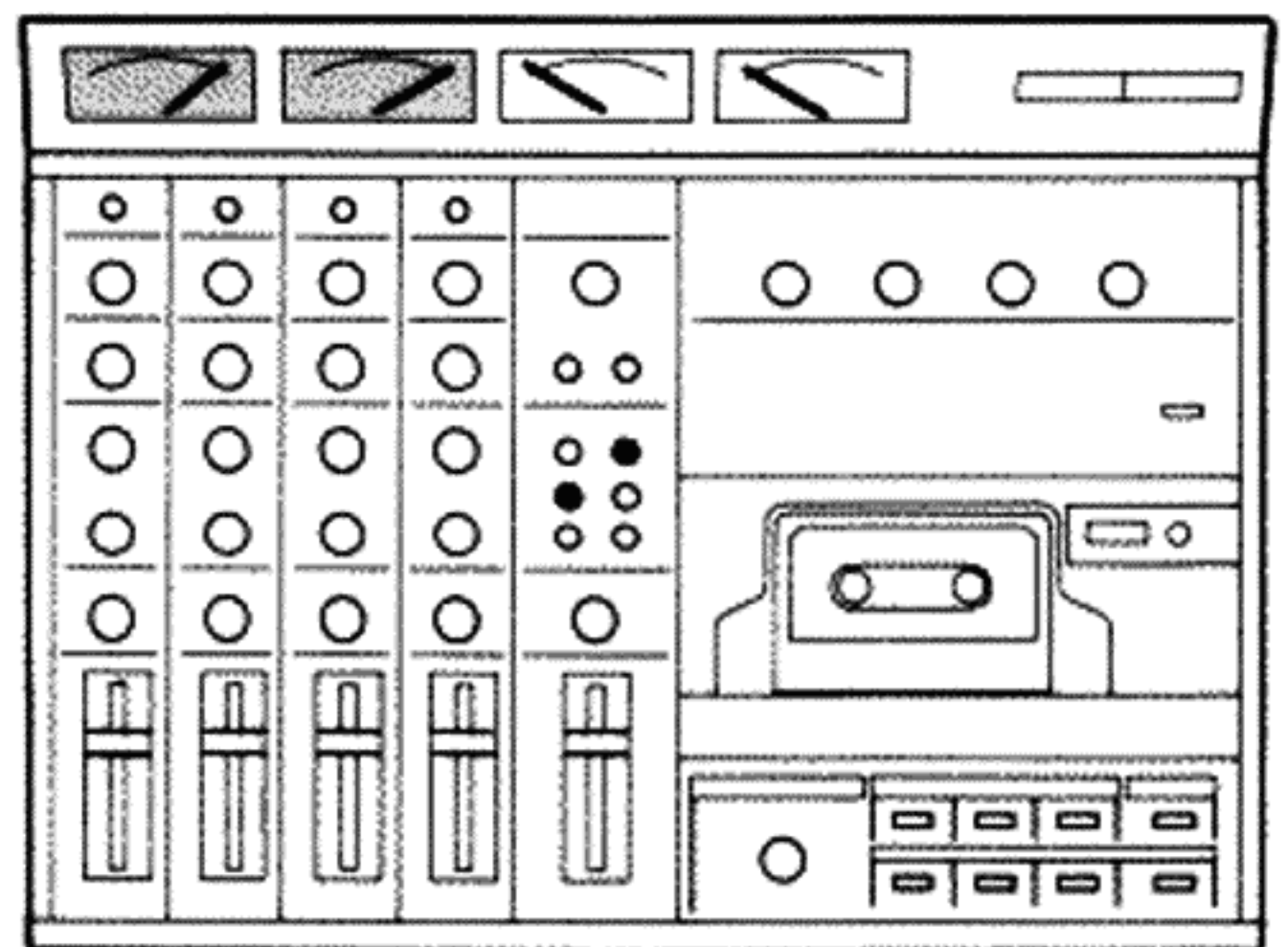
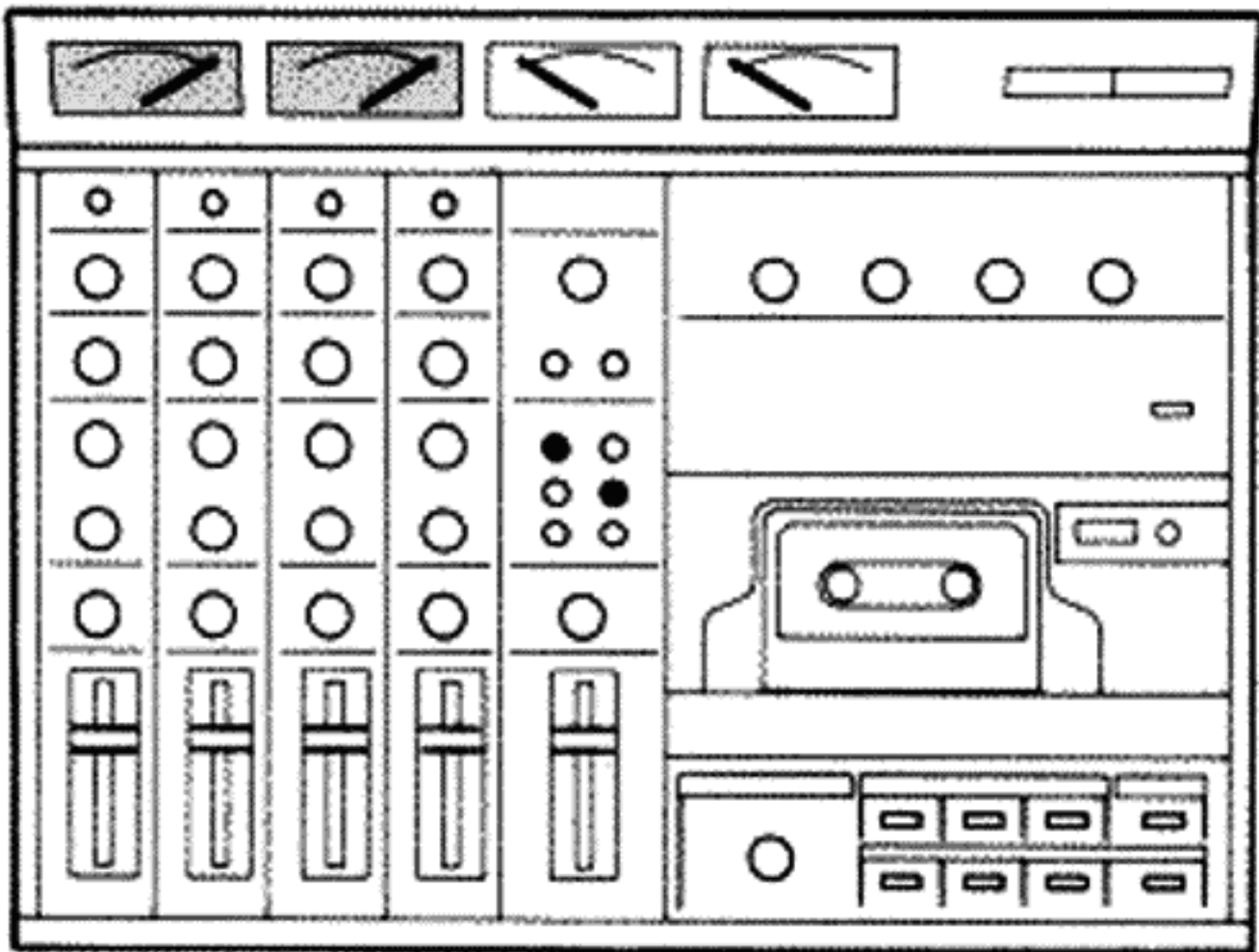
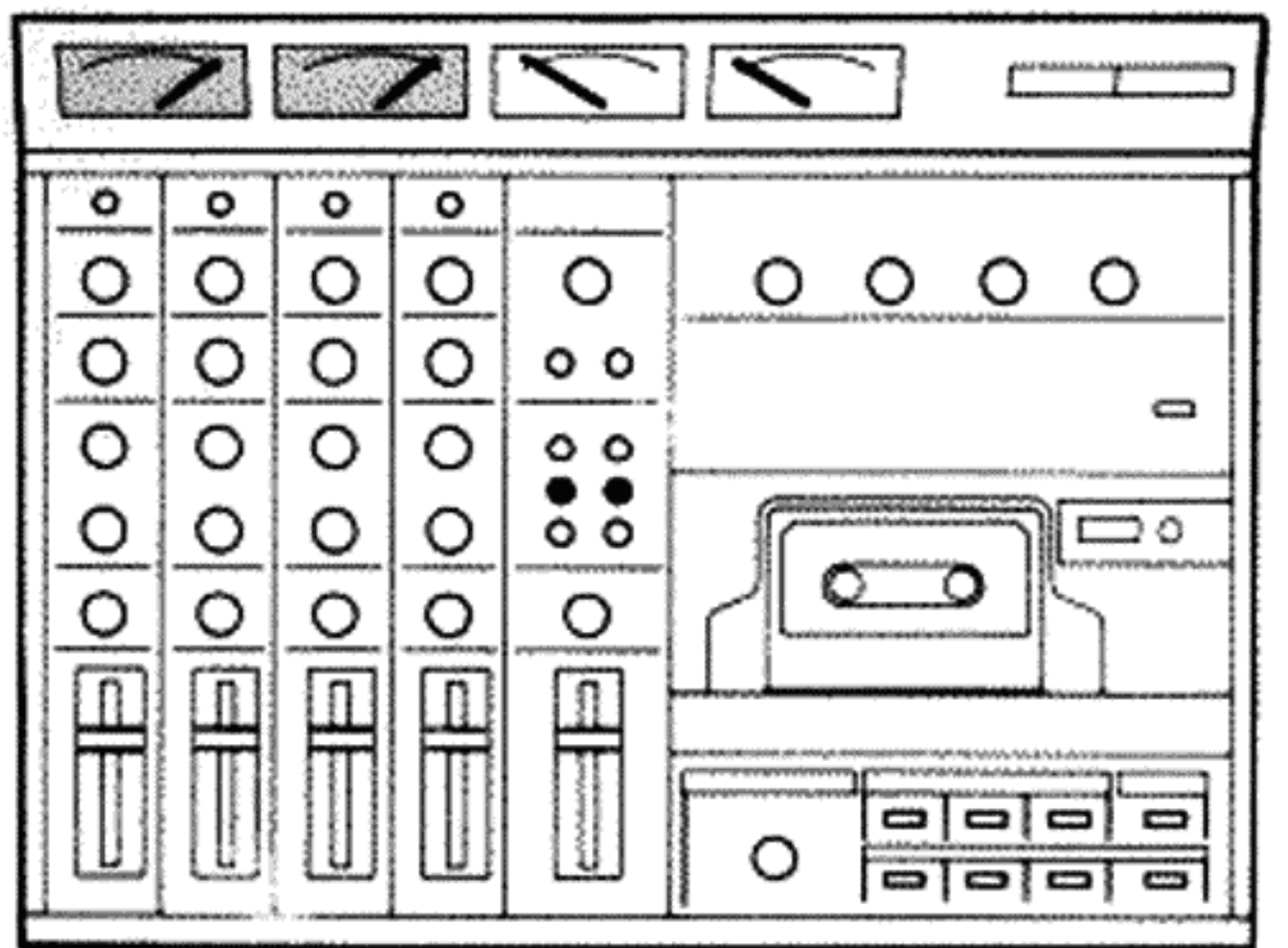
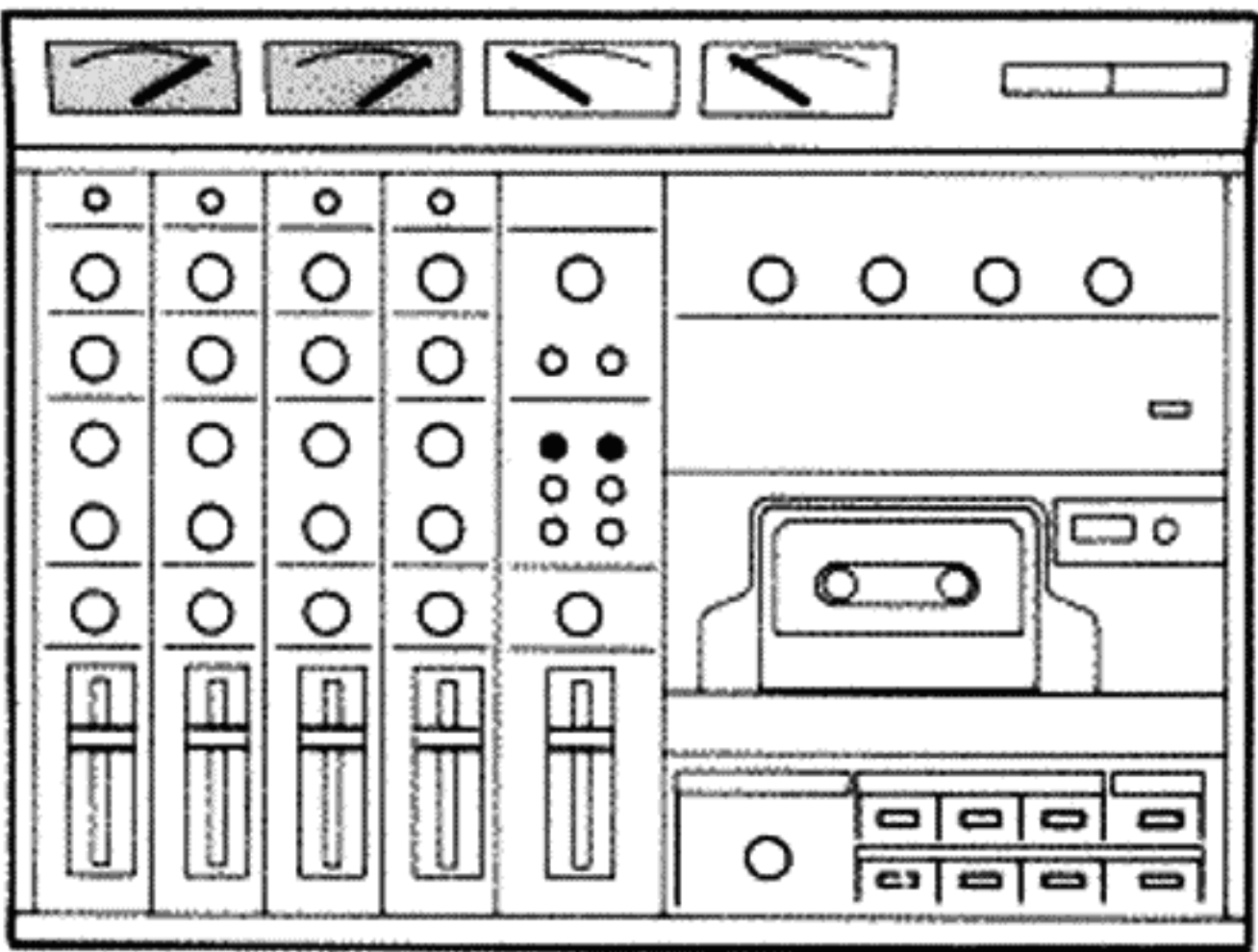
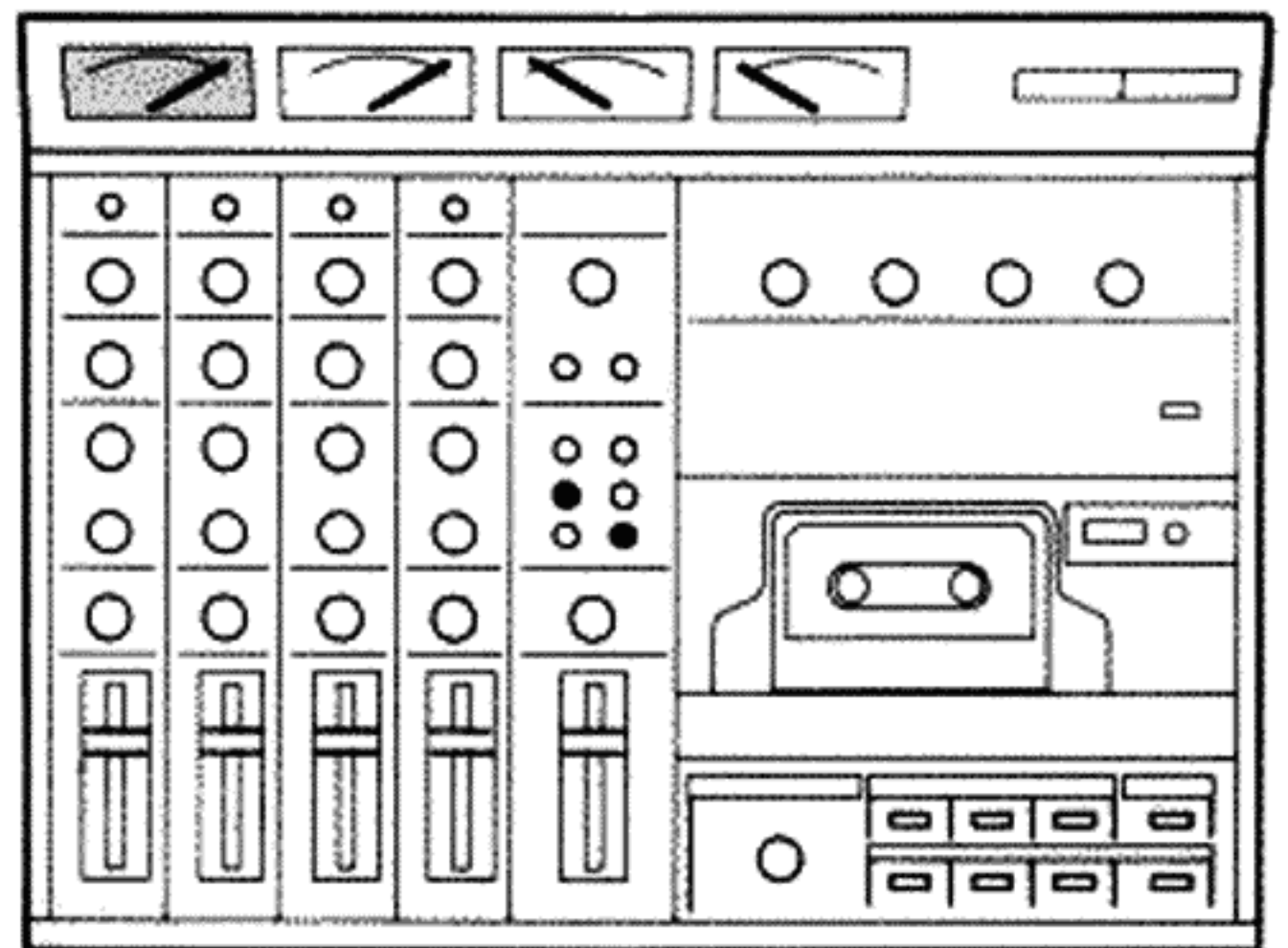
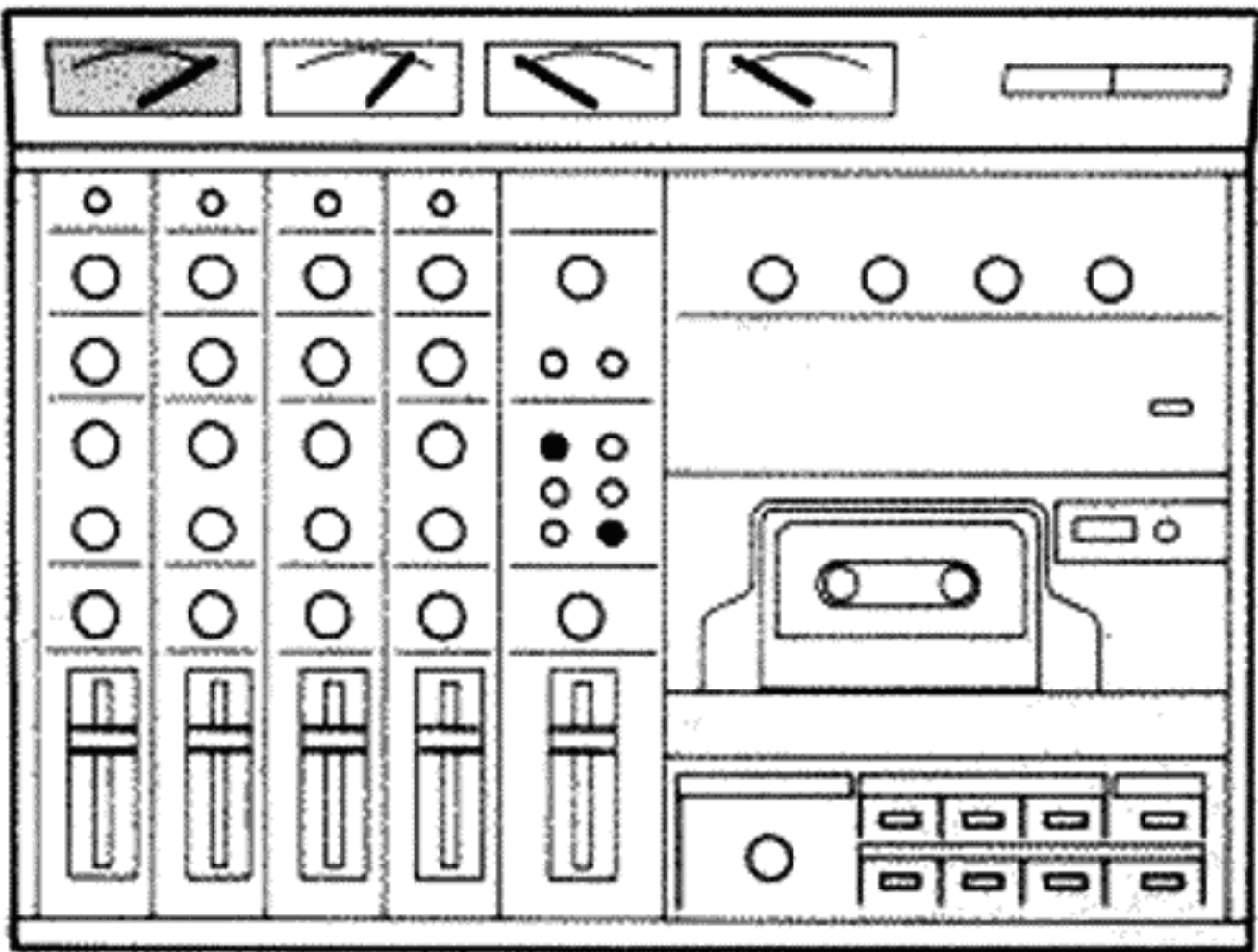
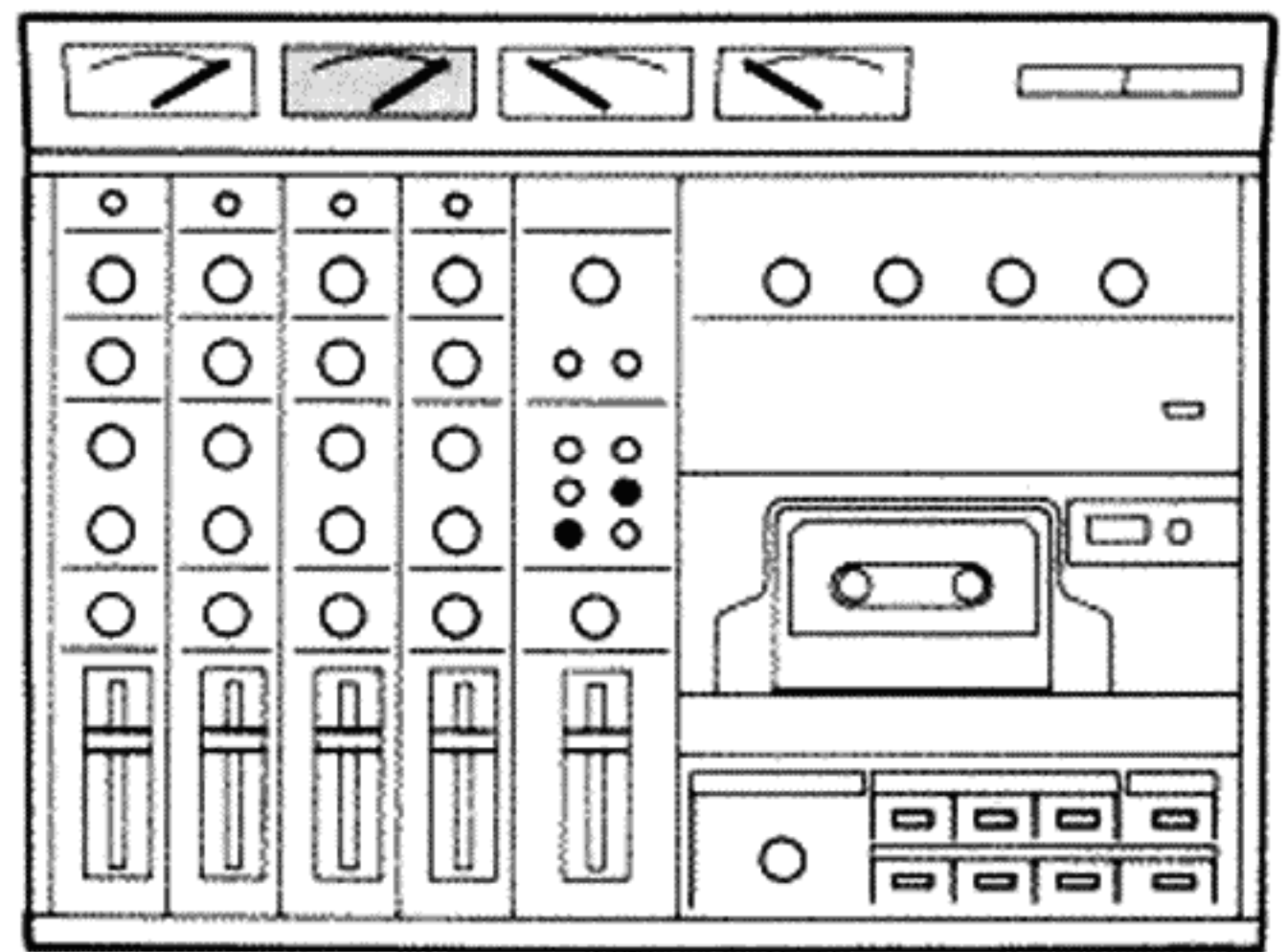
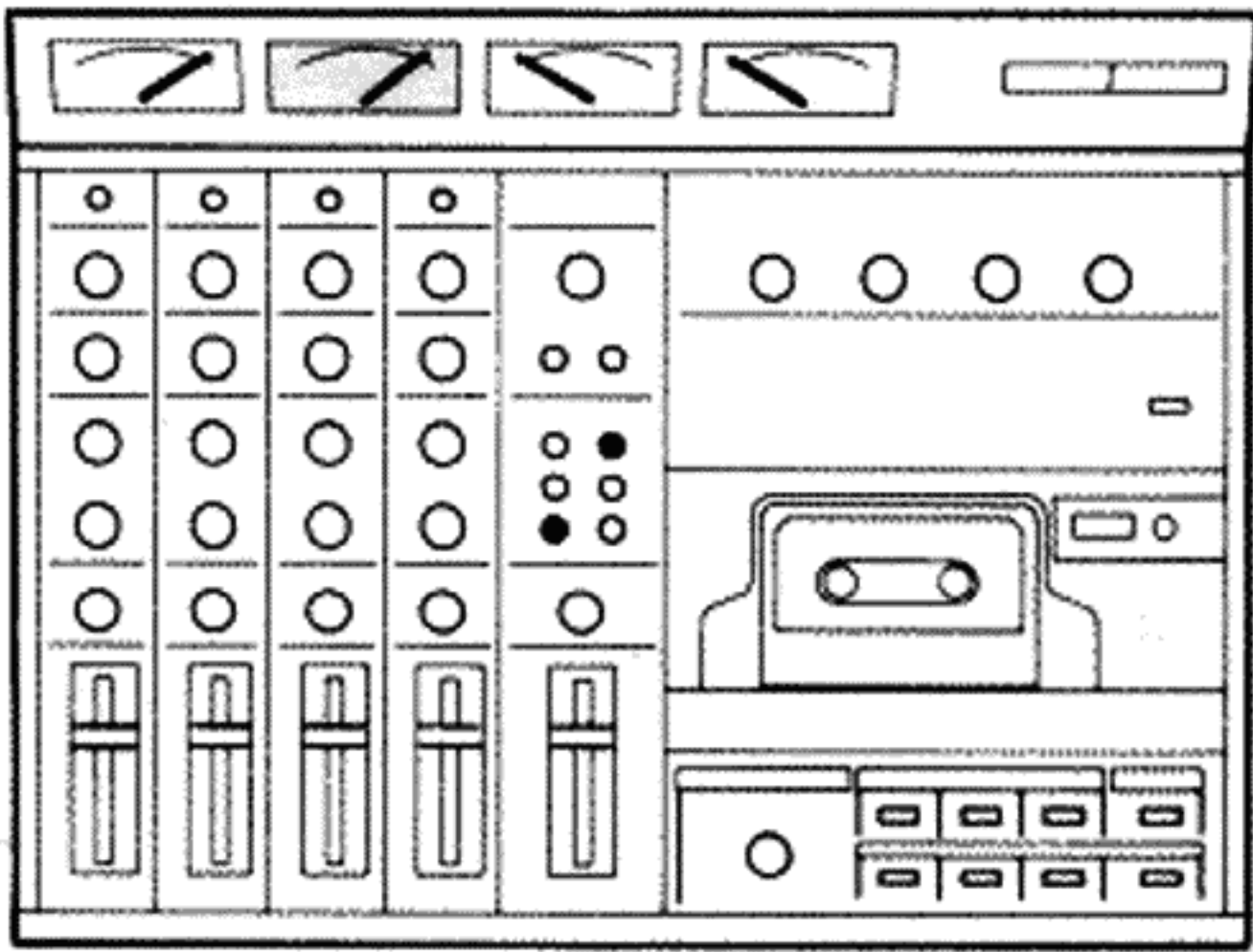

First two meters indicate Buss L&R levels.

REAR PANEL FEATURES

27. PHONES

This stereo headphone jack will feed one set of 8-ohm or higher impedance stereo headphones directly, and up to two sets of phones with a simple "Stereo Y" adapter.

NOTE: If you use two sets of headphones, there may be some loss of volume. For three or more sets of headphones, you will require additional electronics and another (outboard) power amplifier.

CAUTION: DO NOT USE MONO HEADPHONES OR TIP-RING (INSTRUMENT STYLE) CABLES IN THIS JACK. Doing so would connect both amp outputs together, leading to circuit failure. Also, NEVER PATCH THE PHONES OUTPUT DIRECTLY TO ANY OF THE PORTASTUDIO'S INPUTS.

28. LINE OUT (L & R)

This pair of R.C.A. jacks feed a line-level program mix (from the Left and Right Busses) to a monitor amp or tape recorder. This is the same mix you hear in the headphones when the Portastudio is in *remix* mode, except the Line Out level is controlled only by the L-Master-R Fader and not by the Buss/Monitor control.

29. AUX OUT (L & R)

This pair of R.C.A. jacks carry the same line-level program mix as the Line Out jacks. They provide a convenient means to feed another device such as a monitor amplifier or another tape recorder.

NOTE: Do not confuse the Aux Out jacks with the Aux Send jack, a mono effects output.

30. AUX IN (L & R)

These R.C.A. jacks feed an extra stereo input source to the Left and Right Busses. They may be used for returning line-level effects (such as echo, reverb, compression, etc.) to the program which had been sent to the effects unit via the Aux Send jack or Tape Cue jack, or they may be used for spare line inputs to the program. A mono effect can be returned to the "center" of the stereo perspective in the Left and Right Busses by using a "Y" adapter to

feed both these input jacks from the same source. The level of the signal applied to both jacks is adjustable by means of the Aux Receive control.

31. TAPE CUE

This R.C.A. jack carries the mono mix created with the 4 Tape Cue level controls. The line-level Tape Cue output is so called because it is derived exclusively from already-recorded tape tracks when the Portastudio is in *play* mode. This output is useful during mixdown as a pre-fader echo/effects send.

32. AUX SEND

This R.C.A. jack carries a mono mix of the four input channel signals, as determined by the setting of their Aux Send controls. The line-level signal is post-EQ and post-input fader, and can be sent to external auxiliary signal processing equipment such as a compressor, a graphic equalizer, an echo or delay unit, or a reverb.

33. CHANNEL INPUTS (A,B,C,D)

These 1/4" phone jacks are wired directly to the "Mic/Line" side of their respective input channels' Mic/Line-Tape switches. Sensitivity is adjusted from nominal mic level (1 millivolt or -60 dBv) to line level (0.3 volts or 10 dBv) by means of continuously variable Trim controls (one per channel).

NOTE: Any type of mic with an impedance rating of 50 ohms to 10,000 ohms and a minimum level of 0.5 millivolts (-66 dBv) can be connected to the input jacks. (Low impedance mics with balancing transformers are preferable due to their greater rejection of external noise and hum.) Also, any medium line-level source up to a maximum of 2.5 volts (+8 dBv) peak level may be connected here.

CAUTIONS:

Never patch the output of any power amplifier (i.e., a device whose output is rated in Watts) to the channel inputs, or any of the Portastudio inputs, unless a suitable attenuation pad or direct box first drops the level. Such devices are commercially available.

Never connect two Portastudio outputs directly together via a "Y" adaptor or similar method. (It is permissible to use one Portastudio output to feed two inputs on another device via a "Y" adapter, or to feed two Portastudio inputs from an external mono source via a "Y" adapter, so long as the impedances are compatible. Refer to Section 12).

SECTION 1 INTRODUCTION

The TEAC Model 144 is a complete multitrack recording facility built into one lightweight package. That's why we call it the Portastudio.™ The Portastudio combines a full-function 4-channel mixer, the first 4-track cassette recorder with overdub capability, functional record/reproduce signal routing and monitoring systems, and Dolby™ B-type noise reduction.

This manual is organized in a logical sequence for understanding the various Portastudio functions. We first cover the basic techniques so you can gain a solid understanding of the unit. Then we cover some of the more complex functions and techniques. (If you are looking for specific information, consult the index.) It may take you a while to make a tape with which you are satisfied. Making a live multitrack recording is not as simple as taping a record or a radio broadcast; remember that these programs have already been extensively processed by professional engineers.

Most professional recording engineers and producers will agree that the single most important element to a successful recording session is that the artist feel comfortable and confident. We have made this manual as easy to understand as possible so you can quickly acquire that comfort and confidence. Please read it slowly and carefully, and as many times as you need to until you are thoroughly familiar with the fundamentals of recording basic tracks, overdubbing, and mixdown. Because the Portastudio is so versatile, no manual could describe all the possible applications and hook-ups. Therefore, once you *know* the unit, use your own imagination — try your own ideas. The setups and examples in this manual are intended only as a guide.

Things You Should Know About the Portastudio

1. Although the Portastudio can record a maximum of 2 tracks at once, it can record a cumulative total of 4 tracks, and all are recorded with the tape running in the same direction. (This means you cannot turn the cassette over and use side B).
2. It will play up to 4 tracks at the same time.
3. It uses a base speed of 3-3/4 ips.
4. For the reasons cited above, cassettes made on the Portastudio will not play on a standard format cassette machine (1-7/8 ips & 2-tracks in each direction) and vice-versa. (In fact, the track spacing also differs between standard cassette recorders and the Portastudio). Thus, you *will* have to remix and dub (re-record) on another tape recorder to get a compatible 2 track tape to play on standard mono or stereo cassette recorders.
5. We do not recommend C120 cassettes for use in the Portastudio, as explained below.
6. Never use any sharp object or magnetic object near the tape heads. Use only TEAC cleaners on the heads and pinch roller, as described in Section 13.

Which Tapes to Use

Use only *gamma-ferric oxide cassette tapes* that require high bias level (i.e., *chrome* position on most recorders). The record circuitry is designed to function optimally with this type of cassette, which is available from a variety of manufacturers (TDK-SA, MAXELL UDXL-II, or the equivalent). We suggest that you pick one of the above and stick to it.

USE ONLY PREMIUM CASSETTES AND AVOID C-120's. The smaller oxide area of cassette tape compared to open reel makes oxide shedding more significant. In addition, 4 track overdub and replay may require as many as 50 or more plays before you are ready to remix. In order to gain more time from C-120 cassettes, a thinner tape backing (1/2 mil) is used. While such tape may hold up to one stereo recording and occasional playing, the multiple passes through the Portastudio are likely to prematurely wear out or jam a C-120 cassette. For this reason, C-120 cassettes are NOT recommended for use in the Portastudio — in extreme cases, your work may be lost.

Remember that the Portastudio runs at 2 x "normal" speed and records on only one side, so a C-90 runs for 22-1/2 minutes, a C-60 for 15 minutes, a C-45 for 11-1/4 minutes and a C-30 for 7-1/2 minutes.

About Cables

Because most of the functions of a complete multichannel recording system are available by means of switches in the Portastudio, you won't need as many cables as with separate components. Still, you do need cables if you use auxiliary signal processing equipment, an external monitor amplifier, or even a microphone or a line-level input source. We therefore offer these two suggestions:

- a. Keep your cables as short as possible. This reduces signal losses that degrade audio quality, and presents less of an "antenna" to broadcast or random radio-frequency interference (RFI).
- b. Use TEAC low loss cable. It is the best quality cable available, made especially for us by Belden Corporation. The cable has extremely effective braided shielding, very low capacitance (14.5 pico-farads/foot), and multi-stranded center conductors. The Datalene dielectric (center insulation) is flexible enough to avoid kinking, yet stable enough to keep the inner conductors properly centered at all times. The outer jacket is tough vinyl insulation with a "footprint" that tightly clasps the braided shield to prevent "hosing" when the cable is pulled. TEAC cable's center pin is filled with solder, and the shield is soldered 120° around the outer shell of the connector to ensure optimum shielding and reliability. More and more people are realizing that cable *does* make a difference, and TEAC cable is audibly superior.

SECTION 2 RECORDING THE FIRST TRACK

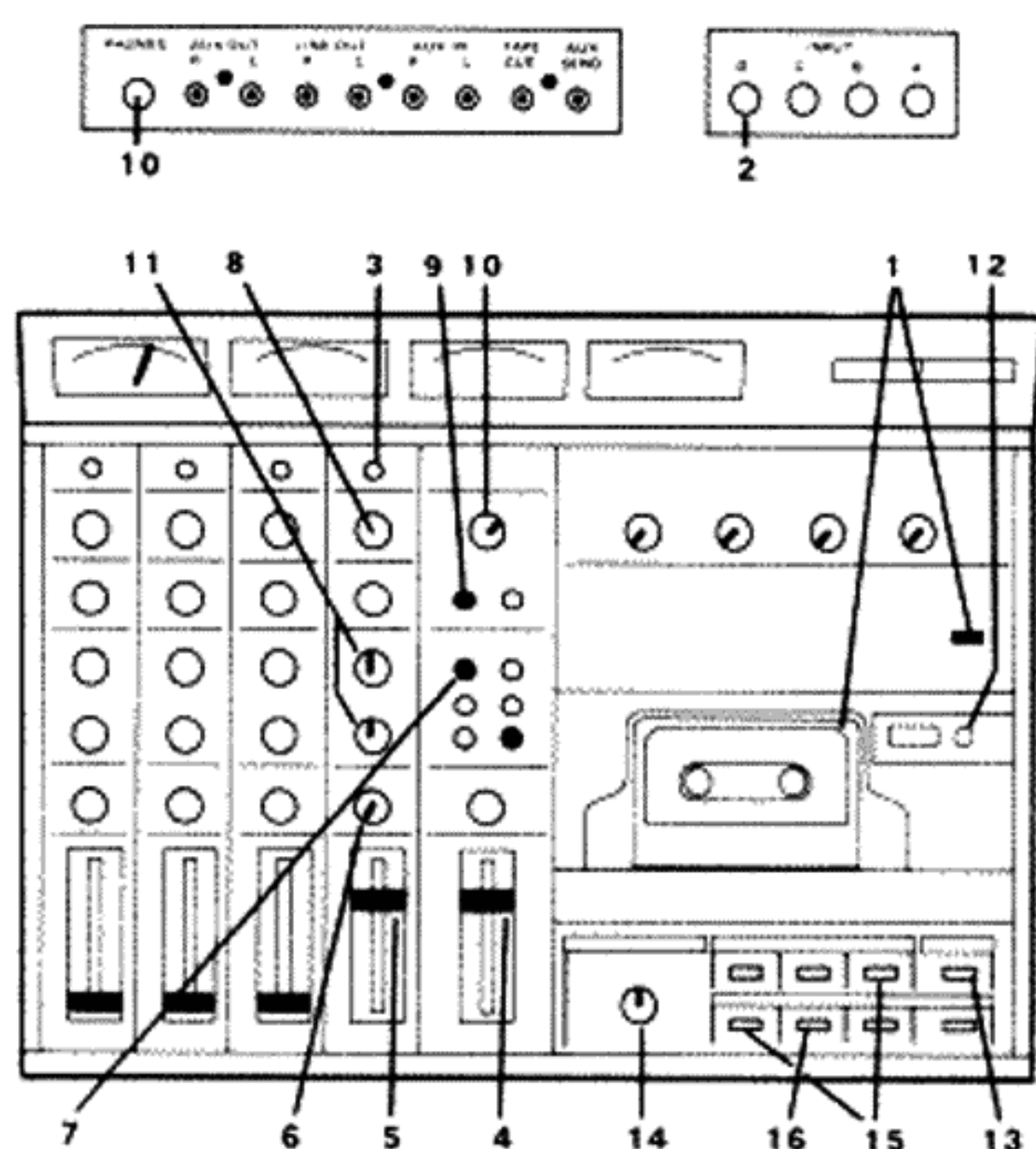

Figure 5 - Typical Portastudio Setup for Recording a Basic Track

1. Turn on the Power, insert a blank cassette, and be sure the tape pack is smooth. (See "Which Tapes to Use" on page 6.)

NOTE: To ensure smooth tape motion, we recommend tapping the cassette on a hard flat surface, with the cassette oriented as it will be when you use it. This packs the tape firmly against the bottom of the shell. Then, after placing the cassette in the Portastudio, fast wind it fully to one end, and then rewind it completely.

2. Plug in a signal source (a microphone or electric instrument) to Input jack D on the rear of the Portastudio.

3. Make sure the channel D Mic/Line-Tape button is up to select the external Mic/Line signal source rather than tape playback.

4. Set the L-Master-R fader to the "nominal" zone (shaded area between #7 and #8 on the control scale).

5. Also set Input channel D's fader to its "nominal" zone.

6. Turn channel D's Pan control to full Left (counterclockwise), thus assigning all the input signal to the Left Buss.

7. Press the Track 1 button on the Record Select switch matrix, thus assigning the Left Buss to Track 1 of the recorder.

NOTE: The red Record Indicator light will now flash ON and OFF. Only the Buss L/Trk 1 VU meter will be illuminated, indicating that recording will take place on the Left-assigned track.

8. Adjust the channel D Trim control so the Buss L/Trk 1 meter peaks between -3VU and 0VU with a typical signal present (i.e., when you're singing into the mic or playing the instrument connected to Input D).

NOTE: You'll need a source of sound to make this operation an actual working experience. While you're learning how the Portastudio works, we suggest you place the mic close to a radio loudspeaker, rather than attempting to play an instrument yourself. The radio will serve as your "musician." A friend will do as well, but if you wish to work in private, any source of sound that doesn't give up will serve. An organ will play continuously if you put a weight on a key, or any motor operated device that won't be damaged by continuous operation will work. (Try a vacuum cleaner.) Later on, the only way to "fine tune" your settings is to actually play an instrument yourself at the normal volume and distance from the mic.

An occasional meter peak in the red zone is OK, but avoid frequent peaks in the red zone as this may cause unwanted distortion. On the other hand, do not record with the average levels too low (i.e., -20 VU) as this will lead to excessive tape noise.

You have now adjusted the unit for the proper recording levels. The monitor level (the level at which you listen with headphones) will be independently adjusted, as described below. Remember to always adjust the record levels by using the Buss L/Trk 1 VU meter, the Buss R/Trk 2 VU meter, or both.

9. Press the Cue button. This places the unit in cue mode (i.e., for mono headphone monitoring). At this time, all four Tape Cue level controls should be set at minimum (counterclockwise).

10. Plug a pair of stereo headphones into the Portastudio Headphone jack, and advance the Buss/Monitor control for a comfortable listening level (when singing into the mic or playing an instrument).

*NOTE: Rotating this control does nothing to the meter reading, and recording would take place successfully, even if you could hear nothing. A good grasp of this kind of **dual** requirement is the basis for successful multichannel engineering.*

IMPORTANT NOTE: The Record Select matrix does not affect the headphone signal. If signal is present on a buss that is not recording you will hear it in the headphones. That is why we have said that one track recording requires full pan to the appropriate buss (the Record Ready one) or you may think you are recording when you are not, and playback will show an unexpected result ranging from too low a level of the partially panned signal, to no result on tape at all.

11. Adjust the channel D equalizer (Bass & Treble controls) as desired, and/or adjust the mic position. (Additional mic & EQ information may be found in Section 11.)

12. Press the Reset button to zero the Counter.

13. Engage the Memory Stop button. Later on this will enable you to quickly rewind to the beginning of the recording.

14. Check the Pitch control to make sure it is

centered for recording at the normal speed (3-3/4 ips).

15. Press the Record and Play buttons simultaneously to make the unit begin recording.

NOTE: Record as long as you like, or until you run out of tape. You may adjust the fader to maintain a good meter level, but DO NOT ADJUST TRIM WHILE RECORDING.

16. When you're done recording, press the Stop button.

To Play Back Your First Track

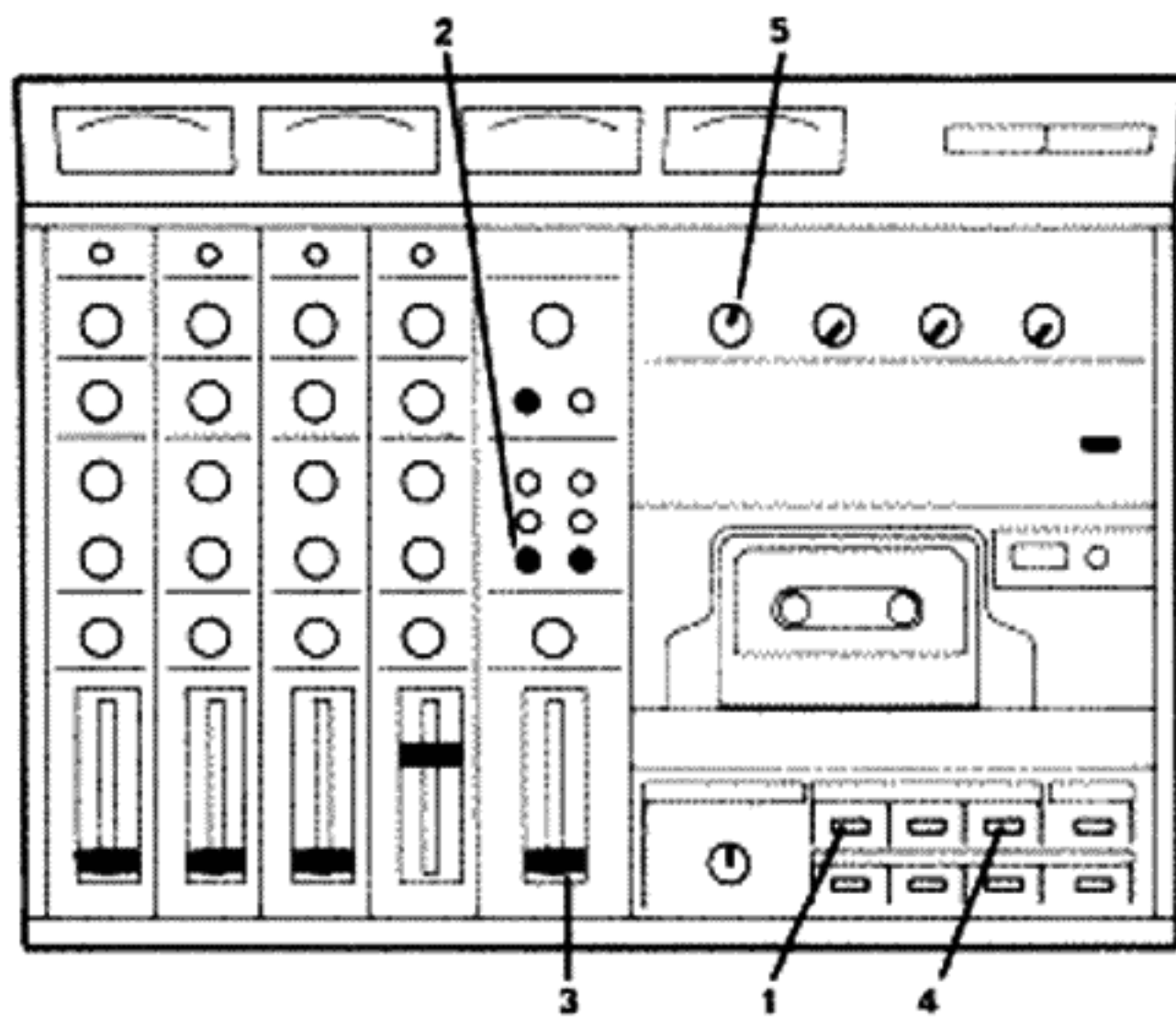

Figure 6 - Typical Setup for Playback of First Track

1. Press Rewind. Because the unit is in Memory Stop mode, the tape will automatically come to a halt at the beginning of this recording "take" (Counter at approx. 000).

2. Press the Left Rec Off button in the Record Select matrix. This places the unit in a safe mode so you cannot accidentally erase your track.

3. Bring the L-Master-R Fader down to minimum (zero). This will prevent the live mic or instrument input from being fed to the headphones, avoiding distraction during playback.

4. Press the Play button.

5. Advance the #1 Tape Cue level control until you hear a comfortable listening level.

NOTE: If you like this first "take", you can continue to set up the Portastudio for an overdub, as described in Section 3. If you don't like this "take", you can re-do it, as described below:

a. Rewind the tape to the beginning of the "take."

b. Press the Record Select Track 1 button to again assign the Left Buss for recording on Track 1.

c. Reset the L-Master-R fader to the nominal position (shaded zone).

d. Record the take again. Since you are using the same track as the original take, that first version will automatically be erased as the new recording is made.

NOTE: If you wondered about the #1 Tape Cue level control that was advanced during playback, it is of no concern here. It only affects signals playing back from the tape. Since Track 1 is now recording, not playing back, the Tape Cue control has no effect. Instead, the Buss/Monitor control sets the level in your headphones.

HINT: It is one thing to write down the name of an album on a conventional cassette tape, but quite another to remember what you have done on a tape all your own. Writing down the tunes is helpful, but even then you will want to know what information is on each of the four tracks, which "takes" are preferred, and perhaps other information. We urge you to make up an informal Track Sheet, photocopy a handful of them, and fill one out to keep with each Portastudio cassette you make. One suggested layout is shown.

TAPE NO. 2		DATE October 5								
Title	Take	TRACKS								Notes
		1	PAN	2	PAN	3	PAN	4	PAN	
"MY SONG"	1	Drum	Ⓛ	Vocal	Ⓢ	Guitar	Ⓛ	1+2	Ⓢ	TRACKS 1 & 2 TRANSFER TO TRK 4 - NOW OPEN ON 1&2
"	2	Piano	Ⓛ	Bass + Vocal	Ⓢ	Guitar	Ⓛ	Drum + Vocal	Ⓢ	Ready for REMIX
			○		○		○		○	
"MY SONG"	RE-MIX		Ⓢ	Ⓢ	Ⓢ	Ⓢ	Ⓢ	Ⓢ	Ⓢ	BOOST GUITAR TREBLE EQ FOR BITE - ROLL OFF PIANO BASS EQ
(REMIX)			○	AUX SEND	○	AUX SEND	○	AUX SEND	○	SEND AUX TO REVERB UNIT & RETURN TO AUX IN L&R

Figure 7 - Sample Track Sheet

SECTION 3 OVERDUBBING

Overdubbing (or "making an overdub") is the process whereby one or more additional tracks are recorded in synchronization with other tracks which have already been recorded. To make an overdub, the recording process is about the same as recording an original track. However, not only do you need to monitor the new sound you are recording, you also have to be able to hear any tracks you previously recorded.

The Portastudio must be in *cue* mode. The Buss/Monitor control adjusts the headphone level of any new sound or sounds you may be recording — assuming the L-Master-R fader, channel fader and Trim controls have been set for the proper record levels using the Buss L/Trk 1 and/or Buss R/Trk 2 VU meter(s) as a guide. The Tape Cue level controls adjust the level of any tracks that have already been recorded.

NOTE: In *cue* mode, all sounds, whether on tape or coming from a new input, will be heard as "center mono."

Overdubbing Procedure

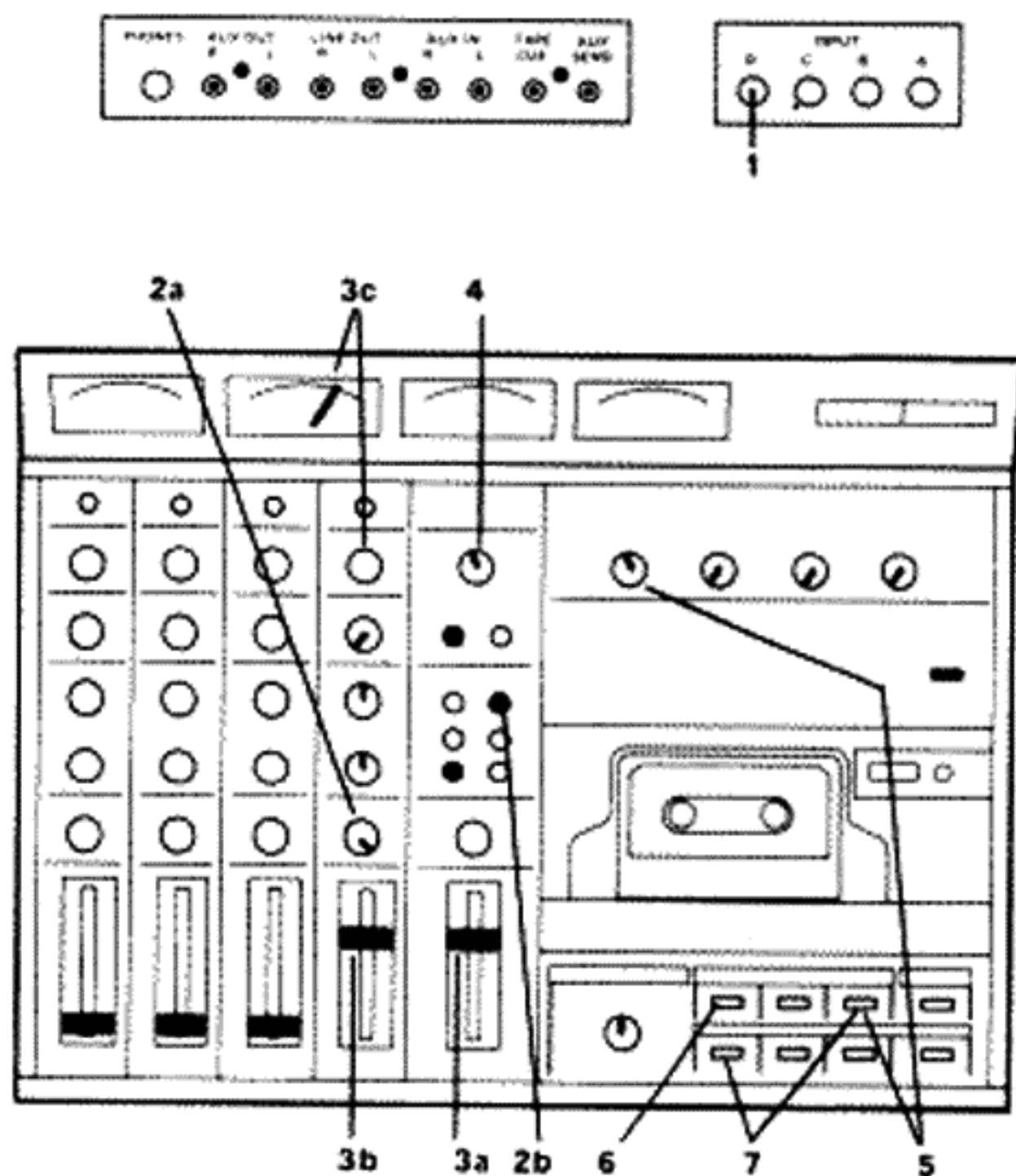

Figure 8 - Typical Portastudio Setup for Overdubbing

1. Connect a mic or instrument to one of the Portastudio input channels. For convenience, we recommend you use input channel D, as you did when recording the original track, even though you will be overdubbing onto a different track of the tape.

2. Decide what track you want to use for recording the overdub. Tracks 2, 3 and 4 are available. For this example, we'll select Track 2.

a. Rotate the channel D Pan control fully right (clockwise) to assign that input to the Right Buss.

b. Press the Track 2 Record Select

pushbutton to assign the Right Buss to record on Track 2 of the tape.

NOTE: Only the Buss R/Trk 2 VU meter light will be ON. The other meters will not be illuminated.

3. Set the new input for proper recording level, as follows:

a. Set the L-Master-R fader at nominal (shaded zone).

b. Set the channel D fader at nominal (shaded zone).

c. Adjust the channel D Trim control so the Buss R/Trk 2 VU meter peaks at between -3 VU and 0 VU with a typical signal present.

4. Adjust the Buss/Monitor control so you can hear the new input at a comfortable listening level.

5. Press the Play button to roll tape, and adjust the #1 Tape Cue level control for a comfortable listening level on the already-recorded track.

NOTE: You can vary the settings of the Buss/Monitor control and the Tape Cue level control(s) to obtain any desired headphone balance (mix). Remember headphone levels are essentially independent of actual levels on the tape. This lets you make one track louder for monitoring, if desired, even though you record all tracks at about the same nominal level on the tape.

6. Press Rewind to get to the beginning of the "take." You are now ready to record the overdub.

7. Simultaneously press Play and Record, and sing or play your instrument along with the previously recorded track. When you're done with the overdub, press the Stop button.

To Play Back Your First Two Tracks

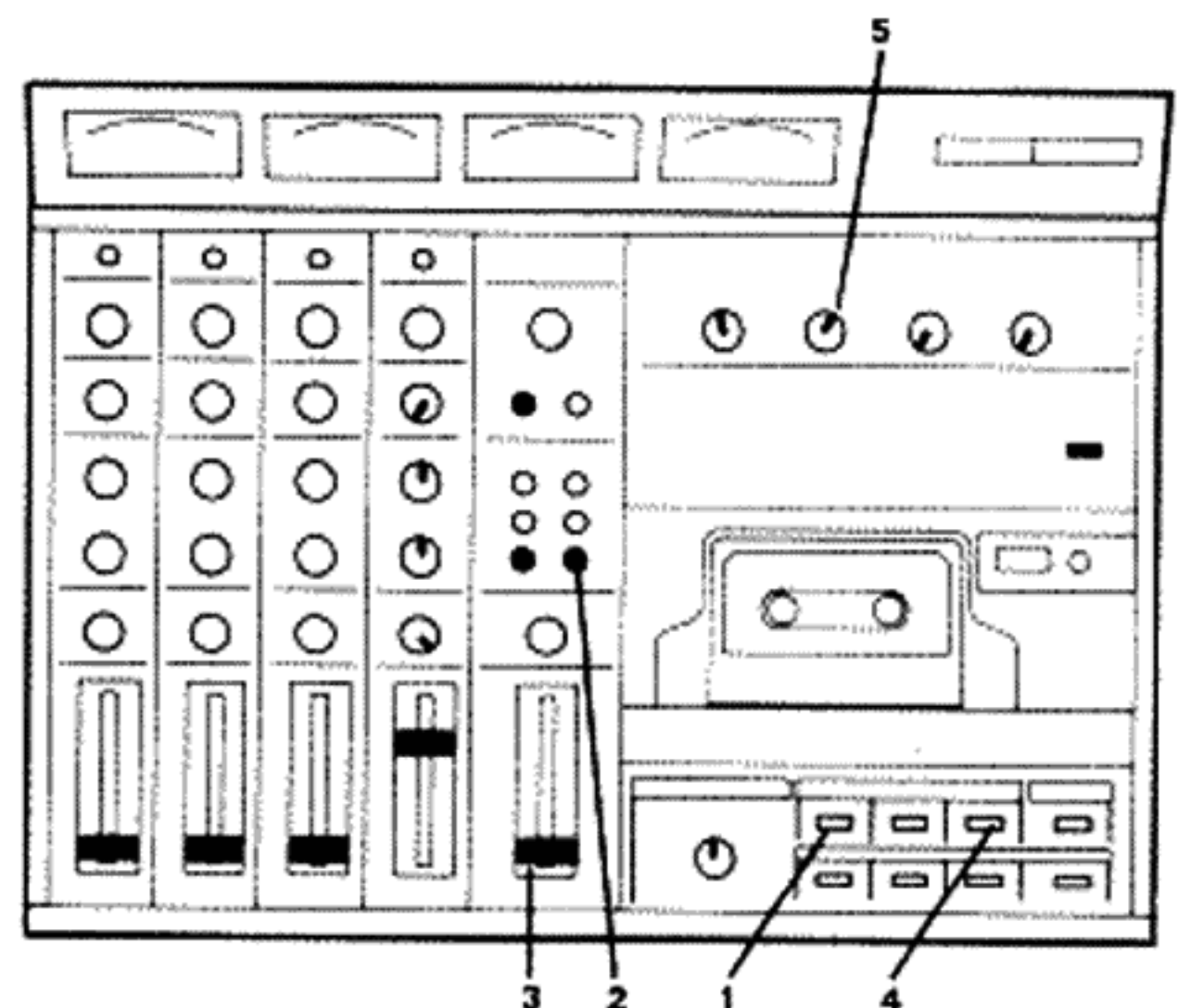

Figure 9 - Setup for Playing Back Basic & Overdubbed Tracks

1. Press Rewind. If the unit is still in Memory Stop mode, the tape will come to a halt at the beginning of the "take."

2. Press the Right Rec Off button. This places the unit in a safe mode so you cannot accidentally

erase your overdub.

3. Bring the L-Master-R fader down to minimum (zero). This will prevent the live mic or instrument input from being fed to the headphones, avoiding distraction during playback.

4. Press the Play button.

5. Advance the #2 Tape Cue level control until you hear the desired balance with Track 1, whose Tape Cue control is already turned up.

NOTE: If you want to overdub additional tracks, you can continue in this same fashion. Use input channel D, set Pan fully Left, and press the Record Select 3 button to record on Track 3 (Left Buss) — or Pan fully Right and press Record Select 4 to record on Track 4 (Right Buss). Remember that the Tape Cue controls always set the playback level in the headphones, and the Buss/Monitor control sets the headphone level of the new sound being overdubbed. Also Remember that only the Buss L/Trk 1 and/or Buss R/Trk 2 VU meter(s) will be illuminated when recording.

IMPORTANT NOTE: After you are satisfied with your 4-Track Portastudio master cassette, remember to label the cassette and **PUNCH OUT THE TWO "PROTECT" TABS** on the rear edge of the cassette housing. This way the cassette cannot be inadvertently erased. (Be sure to knock out *both* tabs — even though you only record in one direction on the cassette, you are filling all four tracks; were you to knock out only one tab, then accidentally turn the cassette over and place it back in the Portastudio, you could still erase it.)

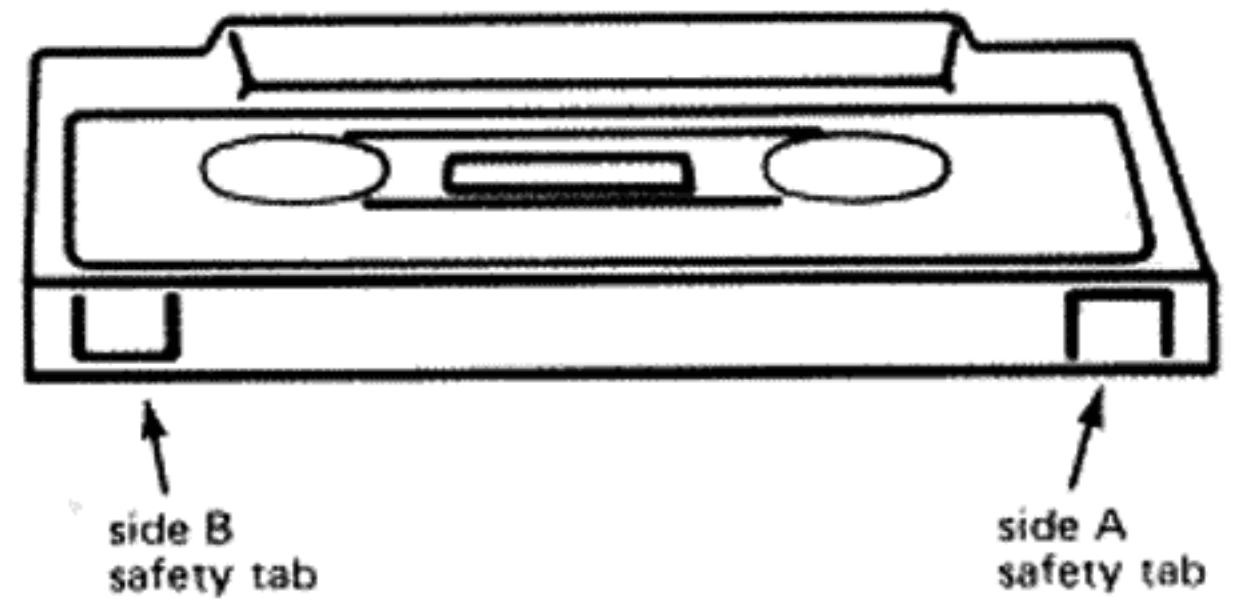

Knock out BOTH tabs to prevent accidental erasure of a completed Portastudio cassette.

Figure 10 - Knocking Out the Record Tabs to Protect a Cassette

SECTION 4 REMIXING

After you have recorded all the tracks, you are ready to remix. Remixing is the process where you establish the stereo perspective (Left-to-Right position) for each track, make final EQ adjustments, and balance the various tracks with one another.

Until now you have recorded one new track at a time, while listening to it and any previously recorded tracks. You listened with headphones, and since the Portastudio was in *cue* mode, you listened in mono. During the remix, you are not working with any new sound sources. Instead, you work with the Portastudio in *remix* mode so you can monitor in stereo as you combine the 4 existing tracks.

You will probably want to remix the master Portastudio cassette several times, "fine-tuning" your mix until it sounds exactly the way you want it.

You can monitor with headphones for remixing. However, you will achieve much greater realism and accuracy if you use an external stereo amplifier and speakers. For this hook-up you can use an integrated stereo amplifier (preamp and power amp combined into one) or a receiver. Connect a dual RCA phono plug cable from the Portastudio's Aux Output jacks to the aux input of your amplifier or receiver. BE SURE TO TURN OFF THE AMPLIFIER AND SET ITS VOLUME ALL THE WAY DOWN BEFORE YOU CONNECT THE PORTASTUDIO TO IT.

To Set Up Your Remix

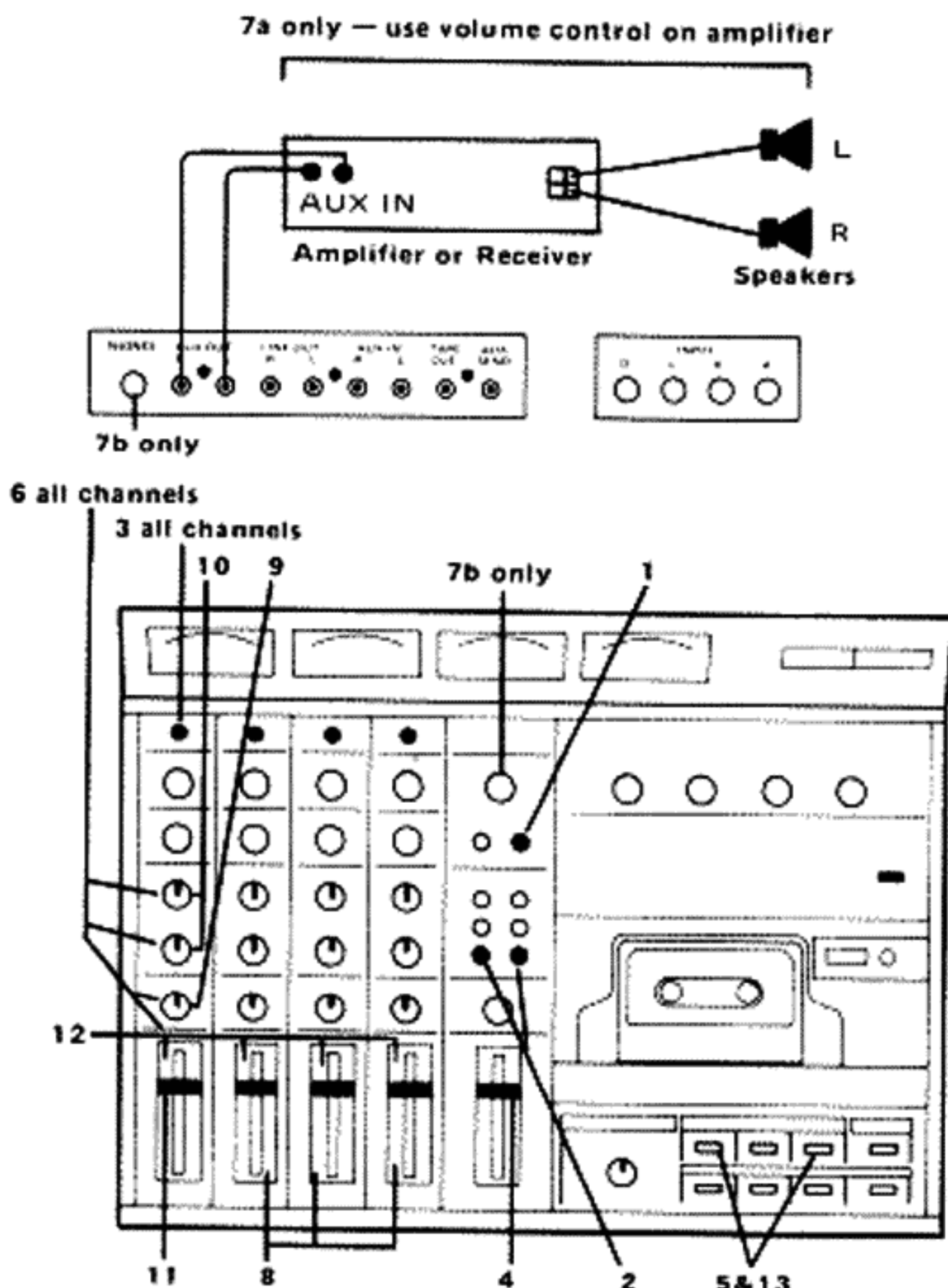

Figure 11 - Typical Setup for Remixing

1. Press the Remix button, placing the Portastudio in *remix* mode for stereo monitoring.

2. Press the two Rec Off buttons in the Record Select matrix so you cannot accidentally erase any tracks.

3. Set all Mic/Line-Tape switches to the Tape position (button down). Remember that channel A corresponds to Track 1, channel B to Track 2, and so forth when you have these switches set for Tape playback.

4. Set the L-Master-R fader to nominal level (shaded zone).

5. Rewind the tape and then press Play, to play the segment.

6. Temporarily set all the input channel faders at nominal (shaded zone), all Pan pots at center, and all EQ controls at "0" (center). This will not be the mix setup you ultimately use, but it provides a good reference while setting levels initially.

7. In order to hear what you are doing:

a. If you are listening via an external amplifier and speakers, turn On that amp and gradually raise its Volume control until you hear the desired level.

b. If you are listening via a pair of headphones plugged into the Portastudio, bring up the Buss/Monitor control for a comfortable listening level.

8. Bring down all the input channel faders except channel A.

9. Adjust channel A's Pan control to place the sound where you want it anywhere from extreme Left to extreme Right.

10. Adjust the EQ controls for the desired sound. (Additional equalizer information may be found in Section 11).

11. Pull down the channel A fader, and bring up the channel B fader. Repeat steps 9 and 10 above. Then do the same for channels C and D.

NOTE: We suggested beginning with channel A, but you can really do the preliminary Pan and EQ adjustments in any channel order.

12. Now bring up all four input channel faders to approximately the nominal setting. At this point you can move some channel faders up a little and others down to balance the level between the tracks for the desired mix.

13. By the time you have made most of these adjustments, you may be near the end of the take. If so, just rewind the tape and play it again so you can achieve the desired mix.

Completing the Mixdown (Dubbing the Remix Onto Another Tape)

NOTE: First check your dubbing tape recorder. If it has a separate output level control, adjust that to its normal setting. If the recorder is a 3-head machine, set its Source/Tape switch to source. You won't want to set the switch to Tape because of the inherent time delay between the record and play heads.

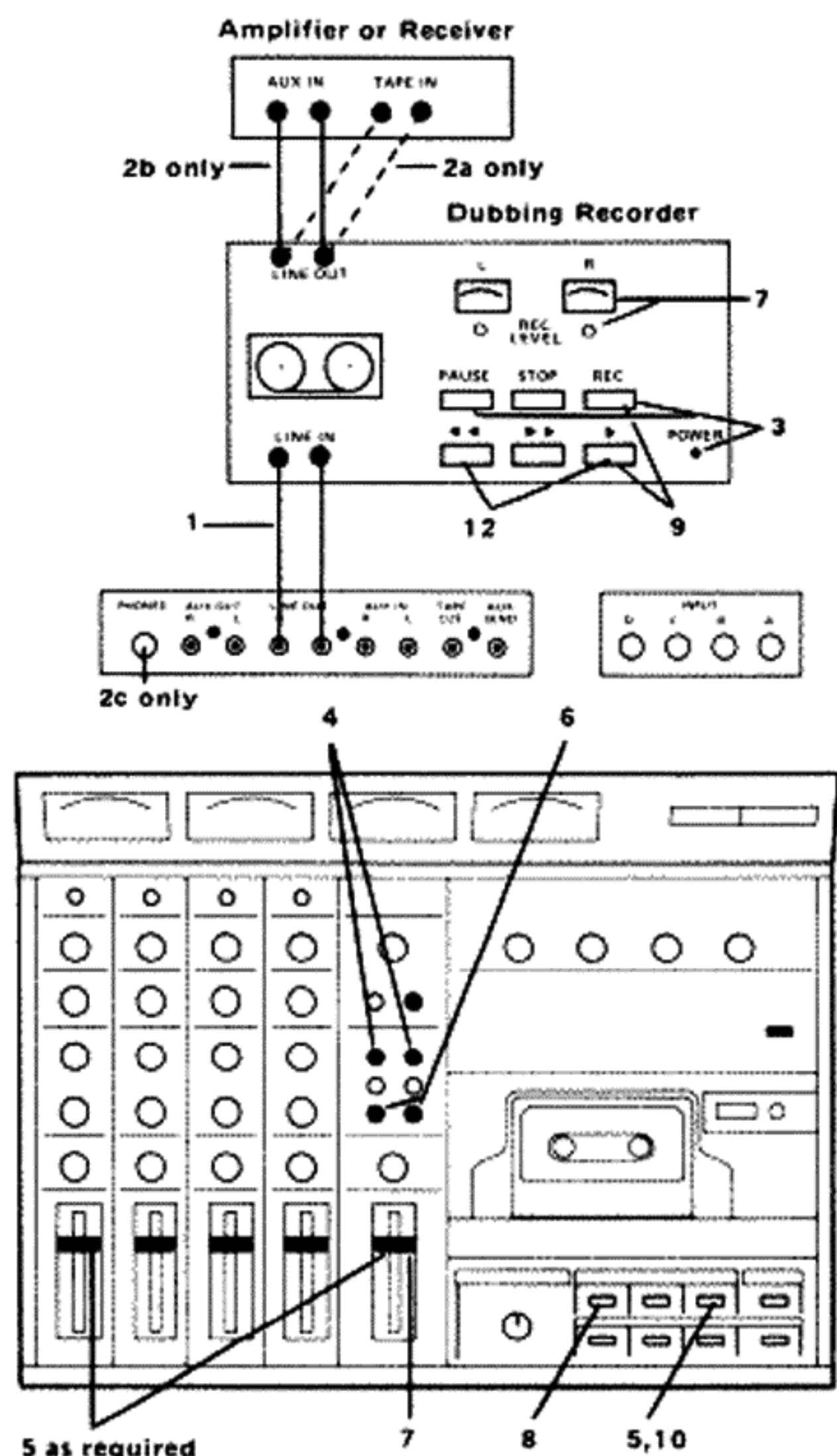

Figure 12 - Setup for Mixdown of a Portastudio Cassette

1. Connect the Portastudio Line Outputs to the line inputs of the dubbing tape recorder.

NOTE: We recommend feeding the dubbing recorder directly from the Portastudio even if your integrated amplifier or receiver has Tape Out jacks. In this way, the signal passes through a minimum of circuitry.

2. In order to monitor the playback from the dubbing machine, you will need to do one of the following:

a. Connect the dubbing recorder's Line outputs to the Tape In jacks on your integrated amplifier or receiver, and set the amp or receiver so you will be able to hear the tape playback.

b. If there are no Tape In jacks, connect the dubbing recorder's Line outputs to a second pair of Auxiliary input jacks on your integrated amplifier or receiver, and set the amp or receiver input selector to pick up that input.

c. If you are using only headphones, unplug them from the Portastudio and plug them into the dubbing recorder.

3. Turn ON the dubbing recorder and place it in *record ready* mode (record/pause or whatever mode will let you set the record levels without actually recording).

IMPORTANT NOTE: At this point it is essential to

establish the proper relationship of the Portastudio's output level to the dubbing recorder's input setting. Remember that you could be listening at a comfortable level and still be recording at the wrong level, so we recommend the following procedures:

4. During remix the Portastudio VU meters have displayed the playback level from Tracks 1 through 4, but not the mix levels on the Left and Right busses. To see the mix levels you are working with, TEMPORARILY PRESS THE TRACK 1 and TRACK 2 RECORD SELECT BUTTONS. This readies the Buss L/Trk 1 and Buss R/Trk 2 meters to display the Left and Right buss level. The other meters will no longer be illuminated.

5. Press the Portastudio Play button. BE SURE YOU DO NOT PRESS THE RECORD BUTTON ON THE PORTASTUDIO, OR YOU WILL ERASE YOUR TAPE. Observe the Buss L/Trk 1 and the Buss R/Trk 2 VU meters. They should be peaking between -6 and 0 VU. If they are somewhat higher, bring down the L-Master-R fader. If they are somewhat lower, raise all the input channel faders.

6. You have now established the desired output level so you no longer need to look at the Portastudio meters. PRESS THE REC OFF BUTTONS ON THE PORTASTUDIO to avoid inadvertent tape erasure.

7. From now on, you can observe the mix level by watching the dubbing recorder's meters. With the Portastudio tape still playing, adjust the dubbing recorder's input level controls so its meters display the proper nominal recording levels specified for the machine.

NOTE: In rare instances, the sound you are monitoring may seem unusually noisy or distorted, indicating a possible level mis-match between the Portastudio and the dubbing recorder. Here are two quick approaches to remedy most situations:

a. If the signal sounds too noisy, bring up the Portastudio L-Master-R fader and bring down the dubbing recorder input level controls.

b. If the signal sounds too distorted, bring down the Portastudio L-Master-R fader. Then, if necessary, bring up the dubbing recorder input level controls.

8. Rewind the Portastudio master tape to the beginning of the "take."

9. Place the dubbing recorder in *record* mode.

10. Press the Portastudio Play button. YOU ARE NOW MAKING THE TRANSFER.

11. If you want to fade out at the end of a take, be sure to note the position of the controls so you can later return to the same settings.

12. To play back the dub, just rewind the dubbing recorder, and place it in play mode. Your monitoring is already set up to hear the tape, unless it is a 3-head recorder, in which case you will have to switch it from *source* or *input* to *tape*.

SECTION 5

PING PONG (COMBINING TWO OR THREE TRACKS TO ONE)

"Ping-Pong" describes the transfer of program material from one place on the tape to another so that additional tracks can be recorded. In its most common form, the ping-pong involves the mixing together of two or three previously recorded tracks and the simultaneous re-recording of that mix onto another "open" (unused) track; the original two or three tracks may then be erased or used for subsequent overdubs. In a variation of the ping-pong technique, one or more "live" sources are mixed with up to three existing tracks, and this combined program is re-recorded onto a single "open" track; once again, the original track(s) can then be erased.

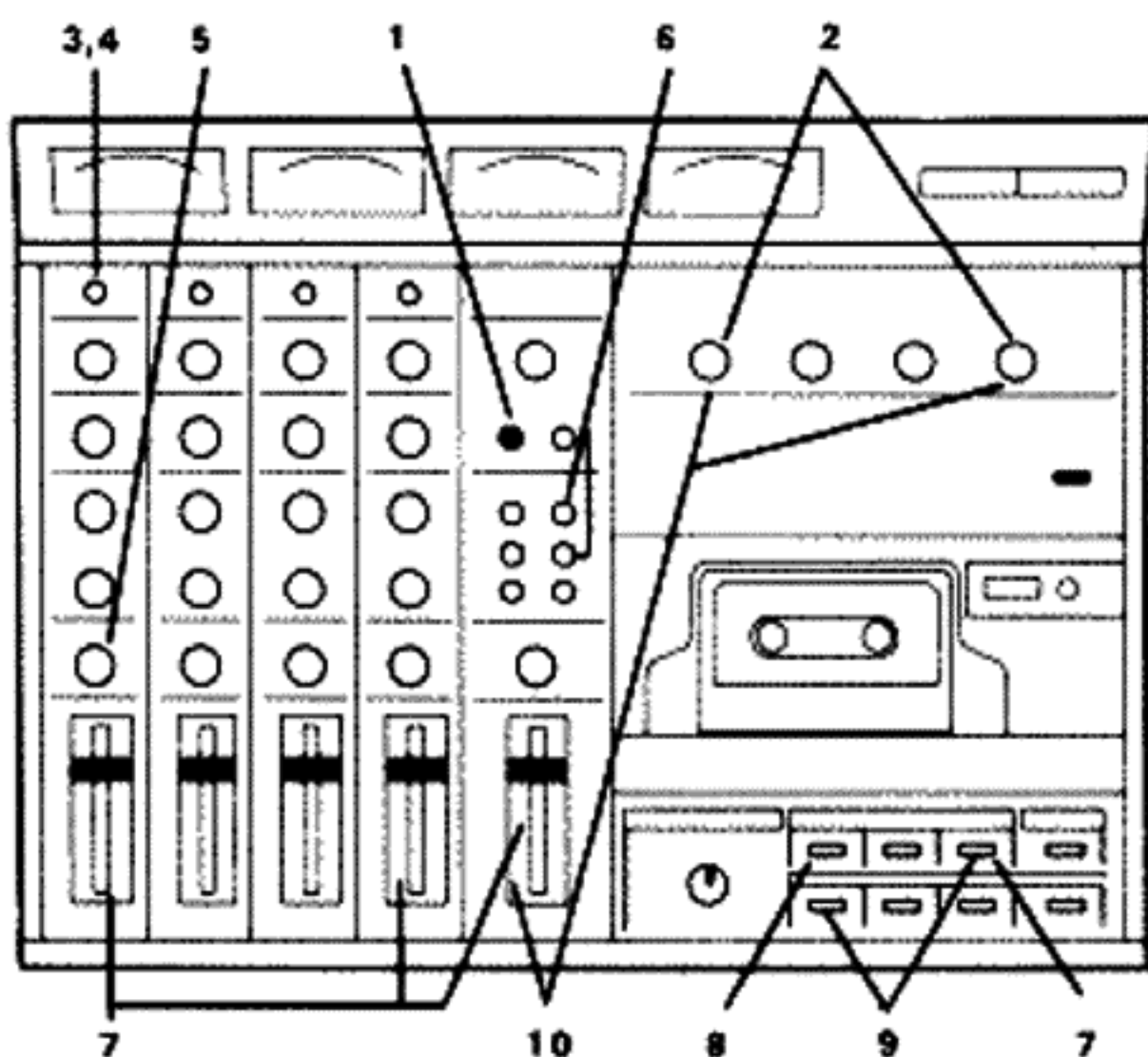

Figure 13 - Typical Setup for Ping-Pong

1. Place the Portastudio in *cue* mode (press the Cue button).

2. Set these Tape Cue level controls at minimum (zero):

- The track(s) being combined, and
- On the track to which the signal is being transferred.

Turning down these Cue controls avoids redundant monitoring of the previously recorded program and ensures that what you hear represents the actual balance being recorded.

NOTE: If you are adding a "live" source, and you wish to hear an existing track which is not part of the ping-pong, you can monitor that track by bringing up the corresponding Tape Cue level control.)

3. Press down the Mic/Line-Tape switches ("tape" mode) on those channels corresponding to the tracks from which signal is being transferred. This brings the pre-recorded track(s) through the input channel(s). Remember that Tracks 1 through 4 will appear on input channels A through D respectively when the buttons are down.

4. If you are also mixing in a "live" source(s) during the ping-pong, bring it to any available input channel(s) and leave that channel's Mic/Line-Tape switch up ("Mic/Line" mode). Remember to set the Trim control in accordance with the basic techniques outlined earlier in Section 2 of this manual.

5. Set the Pan controls of all channels being transferred fully to the Left or the Right, as required to assign signal to the track onto which you are recording (see the chart preceding these instructions).

6. Engage the appropriate Record Select button for the track onto which you are recording.

7. Play the tape and adjust the channel faders on the tracks being combined (and on any new inputs) for the desired program balance. If the overall balance is OK, you still may have to bring down the L-Master-R Fader a bit to keep the illuminated VU meter in the nominal range.

8. Rewind the cassette, and you're ready for the ping-pong.

9. Simultaneously press Play and Record to make the transfer.

10. To evaluate the recording, rewind the tape, pull down the L-Master-R fader, and bring up the Tape Cue level control for the track onto which the transfer was made. If you're not satisfied with the transfer, you can rewind, make any necessary adjustments, and re-record over the same track.

CAUTION: When making ping-pong recordings from one track to an adjacent track, from track 3 to track 2 or 4, for example, do not set the channel faders set higher than the shaded zone and avoid setting the treble controls to an excessively high position.

If such extreme settings are unavoidable when making ping-pong transfers, do not use adjacent tracks, otherwise feedback/oscillation is likely to result.

SECTION 6 STEREO/2-TRACK TRANSFERS

Two existing tracks can be simultaneously transferred to two unused tracks of the tape, and new sounds can be added to the program at the same time. This technique is really a variation of the "ping-pong".

In theory, this back-and-forth transfer routine can be used more than once, adding an instrument to the "stereo" each time you "bounce" or "ping-pong". In practice, noise will build up rapidly and limits the use of this stereo/2-track transfer method to perhaps a single time. The ping-pong is otherwise similar to the mono ping-pong. Be sure to pan the tracks fully Left and fully Right. If you wish to monitor in stereo, switch to *remix* mode and turn down the Tape Cue controls.

Sound Source (Existing Track or New Input)	Input Channel & Mic/Line-Tape Switch Position	Track onto which the Existing Track & New Program may be Placed	Set Channel Pan Controls as shown
Track 1 Track 2 New Input New Input	Ch. A – Tape Ch. B – Tape Ch. C – Mic/Line Ch. D – Mic/Line	3 4 3 &/or 4 3 &/or 4	Full Left Full Right As Desired As Desired
Track 3 Track 4 New Input New Input	Ch. C – Tape Ch. D – Tape Ch. A – Mic/Line Ch. B – Mic/Line	1 2 1 &/or 2 1 &/or 2	Full Left Full Right As Desired As Desired
Track 2 Track 3 New Input New Input	Ch. B – Tape Ch. C – Tape Ch. A – Mic/Line Ch. D – Mic/Line	1 4 1 &/or 4 1 &/or 4	Full Left Full Right As Desired As Desired
Track 2 Track 3 New Input New Input	Ch. B – Tape Ch. C – Tape Ch. A – Mic/Line Ch. D – Mic/Line	4 1 1 &/or 4 1 &/or 4	Full Right Full Left As Desired As Desired
Track 1 Track 4 New Input New Input	Ch. A – Tape Ch. D – Tape Ch. B – Mic/Line Ch. C – Mic/Line	3 2 2 &/or 3 2 &/or 3	Full Left Full Right As Desired As Desired
Track 1 Track 4 New Input New Input	Ch. A – Tape Ch. D – Tape Ch. B – Mic/Line Ch. C – Mic/Line	2 3 2 &/or 3 2 &/or 3	Full Right Full Left As Desired As Desired
Track 1 Track 3		2 4*	
Track 2 Track 4		1 3*	

*These transfers are not possible.

Stereo/2-Track Transfer Track Assignment Chart

SECTION 7 STEREO/2-TRACK RECORDING

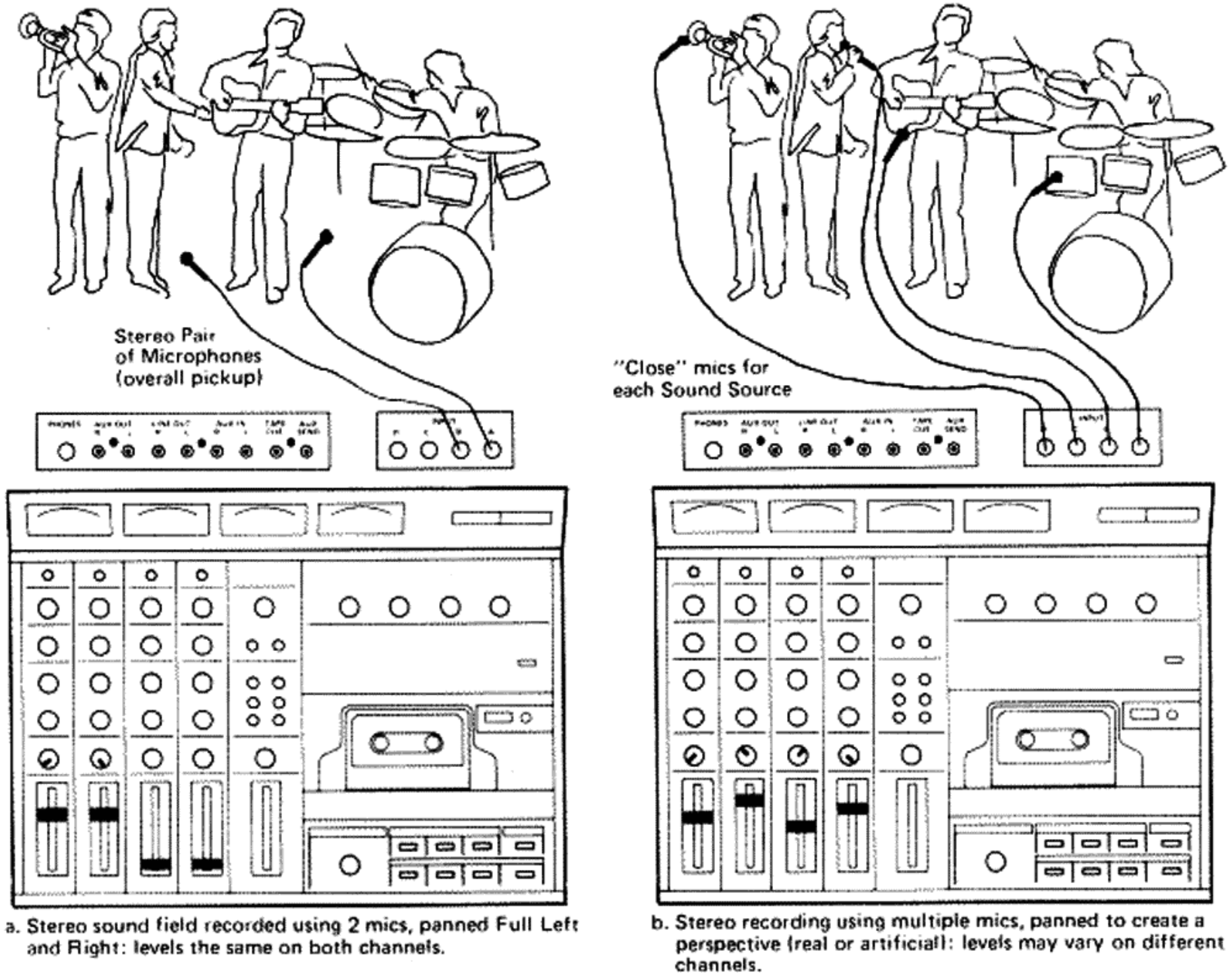

Figure 14 - Pictorial Representation of Stereo Recording

When you record on two tracks at the same time, you may or may not be making a "stereo recording." If the two tracks have unrelated material, perhaps an electric instrument on one channel and a vocal mic on the other, then you are making two simultaneous mono recordings, and the technique is known as "2-track recording." If the two tracks are used to create a panoramic sound image, then the technique is known as "stereo recording." There are two basic varieties of stereo recording:

- There are only two mics, and these are recorded with one channel assigned completely to one track and the other channel to the other track to preserve the stereo sound field.
- There are 3 or 4 inputs, and these inputs are assigned to the two tracks being recorded by adjusting the Pan controls to create any desired stereo perspective.

Either stereo recording or 2-track recording may be done as basic tracks (i.e., the initial "take") or as an overdub. Because most of the steps are the same in a stereo basic track or overdub, we have combined the procedures and indicated any differences.

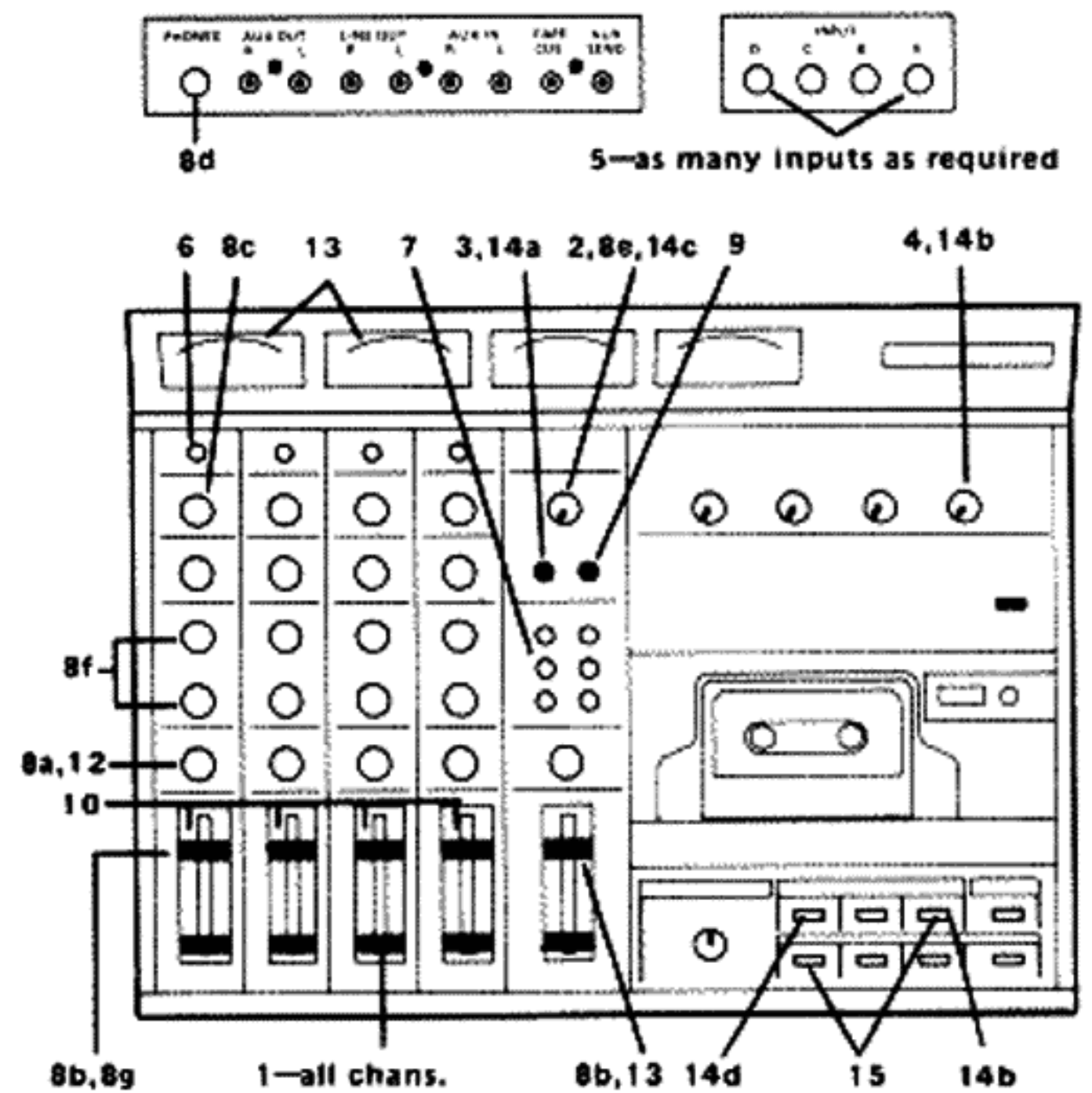

Figure 15 - Typical Setup for Stereo/2-Track Recording

- Set all channel faders and the L-Master-R fader at #0 (all the way down).
- Set the Buss/Monitor control at #0.
- Press the Cue button to place the Portastudio

in *cue* mode. Since you will be auditioning each of the input sources individually, this prepares you to listen in mono with the headphones.

4. Turn down all the Tape Cue level controls to #0 (if this is an overdub, you are not initially interested in hearing existing tracks, but only in auditioning new ones).

5. Plug in the microphone or line level input sources to any input channels.

6. Set all four Mic/Line-Tape switches to *Mic/Line* position (buttons up).

7. Press the Record Select switches for the two tracks onto which you plan to record (i.e., one Left-assigned track and one Right-assigned).

8. In order to audition each input source without confusion from the others (to "solo" the inputs), perform the following sequence once for each channel that carries a new input:

a. Rotate the channel's Pan control fully Left. This temporarily isolates the signal in order that its initial level and EQ may be more easily adjusted. Later the Pan control may be reset.

b. Slide the L-Master-R fader and the channel fader to the nominal setting (shaded zone).

c. With a typical signal present at the input (i.e., someone using the mic or playing the instrument), set the channel's Trim control for a nominal VU meter indication (i.e., peaks from -3 dB to 0 dB). Only the Buss L/Trk 1 VU meter will be moving at this point, although the Buss R/Trk 2 VU meter also will be illuminated.

d. Plug in a set of stereo headphones so you can listen to the program. (Refer to the Phones jack description in the rear-panel callouts at the front of this Manual.)

e. Raise the Buss/Monitor control to obtain a comfortable listening level. (If you are using an external headphone amplifier driven from the Portastudio headphone jack — for multi-headphone setups during overdubs — begin with the Buss/Monitor control set at #3.)

f. Set the channel equalizer and/or adjust the microphone placement to obtain the desired sound quality.

g. Return the channel fader to #0.

h. Repeat steps A through G above for the next input channel being used for the stereo recording until all channels have been set up.

9. Press the Remix button so you can monitor in stereo.

10. Slide the channel faders to the nominal setting (shaded zone) on all the input channels you just auditioned.

11. Have all of the musicians and/or vocalists perform whatever program you intend to record.

12. Set each input channel's Pan control for the desired stereo perspective.

NOTES (Refer to Figures 14 & 15):

a. *If you are using a pair of mics to pick up the stereo perspective, recording them directly*

onto two tracks, then pan one input fully Left and the other fully Right. This applies the same stereo perspective "heard" by the mics directly to the tape.

b. *If you are using a pair of mics (or line inputs) to pick up two unrelated sources that you simply wish to record simultaneously on different tracks, then pan one fully Left and the other fully Right. (Such tracks can be re-positioned later during the remix.)*

c. *If you are using several inputs, then pan them wherever you wish until you hear the desired stereo panorama in the headphones.*

13. Observe the Buss L/Trk 1 and Buss R/Trk 2 VU meters. If you are using three or more inputs, the combined levels may get a bit too high; in that case you can bring down the L-Master-R fader to obtain the proper nominal VU meter levels. It is not necessary or even desirable that the two meters give identical indications, but generally they should both peak in the area of -3 dB to 0 dB.

NOTE: *Remember that if the sound is too loud or soft in the headphones when the VU meters are displaying the desired levels, use the Buss/Monitor control to adjust the level. Do not use the channel faders or L-Master-R fader as this will interfere with optimum recording.*

14. If you are *not* doing an overdub, go on to Step 15. If you are overdubbing, you and the performers will need to hear the already-recorded tracks as well as the new sounds being recorded. This requirement is met by the following procedure (14a-14d).

a. Press the Cue button. You no longer need to monitor the stereo perspective. While placing the unit in *cue* mode produces a mono headphone mix, it lets you listen to the already recorded tracks via their Tape Cue level controls; new inputs are still fed to the headphones via the Buss/Monitor control. Remember that even though you are monitoring in mono, you will be making a stereo/2-track recording.

b. Play the cassette (but don't record yet). Adjust the Tape Cue level controls for a meaningful balance and comfortable sound level of already recorded tracks.

c. Have the musicians and/or vocalists perform while you are playing the cassette and adjust the Buss/Monitor control for the desired headphone level. You will be also be hearing the existing tracks since their Tape Cue controls are up.

d. Rewind the cassette to the beginning of the take, and proceed to the next step (recording).

15. Press Play and Record to record the performance. When you're finished recording, press Stop. Also press the Record Select Off buttons to avoid inadvertent erasure during playback.

To Evaluate the Stereo/2-Track Recording

There is more than one way you can monitor the playback. You will notice that mono playback for quick reference is a very simple procedure, whereas stereo playback can become rather involved. Since you already checked the stereo balance when you were setting up the recording, you may just want to play back in mono for a check of the signal.

NOTE: Be aware that apparent hiss will be excessive in this mono playback mode, even though the tape is not noisy. This mode is useful primarily for a check of the "timing", and quiet playback will not be feasible until the Portastudio is switched to the mixer playback method (i.e., the input channels' Mic/Line-Tape switches in Tape mode).

MONO PLAYBACK

You can quickly monitor the tape in mono by rewinding it, setting the L-Master-R fader at #0. Since you are already in cue mode from Step 14A, just set the Tape Cue level controls to hear a headphone mix of the tape. If you want to re-do the take, rewind the tape and start all over again.

STEREO PLAYBACK

If you want to check the stereo balance of your basic track or overdub, follow this procedure. You can either use headphones or an external stereo amplifier and a pair of speakers.

fader at #0.

3. If using Speakers, connect either the Portastudio's Line Out or Aux Out jacks to the Aux inputs of your stereo amplifier or receiver.

4. Press in the Mic/Line-Tape buttons on any input channels you wish to monitor.

5. Set the Treble and Bass controls at #0 (center) on the channels to be played.

6. On the two channels corresponding to the stereo-recorded tracks, rotate one Pan pot fully counterclockwise and the other fully clockwise (i.e., all the way Left and Right). This ensures you will hear the full separation and stereo perspective on these channels. If you want to reverse the stereo, just reverse the Pan pot positions.

7. If your stereo recording was an overdub and you also wish to hear the other track(s), pan them to any point along the stereo perspective.

8. Slide the playback channels' faders and the L-Master-R fader to nominal (shaded zone).

9. Rewind the tape and press Play. Use the Volume control on your stereo amplifier to set the speaker level. Alternately, for headphones adjust the Buss/Monitor control. If you need to balance overdubbed tracks with basic tracks, adjust the channel faders.

10. If you want to redo a basic stereo track, you have three choices: you can use a fresh cassette (a safe way to ensure you won't run out of time), use remaining time on the same cassette (so you can compare first and second takes), or simply rewind and re-record over the first take (when tape is scarce). If you want to redo a stereo overdub, you have only one choice — rewind and re-record over the first attempt.

NOTE: If you are redoing a recording, return all controls to their pre-playback positions (i.e., before Step 1 of this playback procedure). These settings may nonetheless produce unexpected results because the performance itself may differ from the original. In that case, the best technique — albeit time consuming — is to start all over with Step 1 of the recording procedure, including setting all the levels and EQ.

CAUTION: IF YOU ARE GOING TO AGAIN RECORD, TURN DOWN THE VOLUME ON YOUR AMPLIFIER (or, safer still, turn off the amplifier). A "live" amplifier/speaker system in the presence of an "open" mic is likely to cause severe feedback (howling) that could easily damage your speakers.

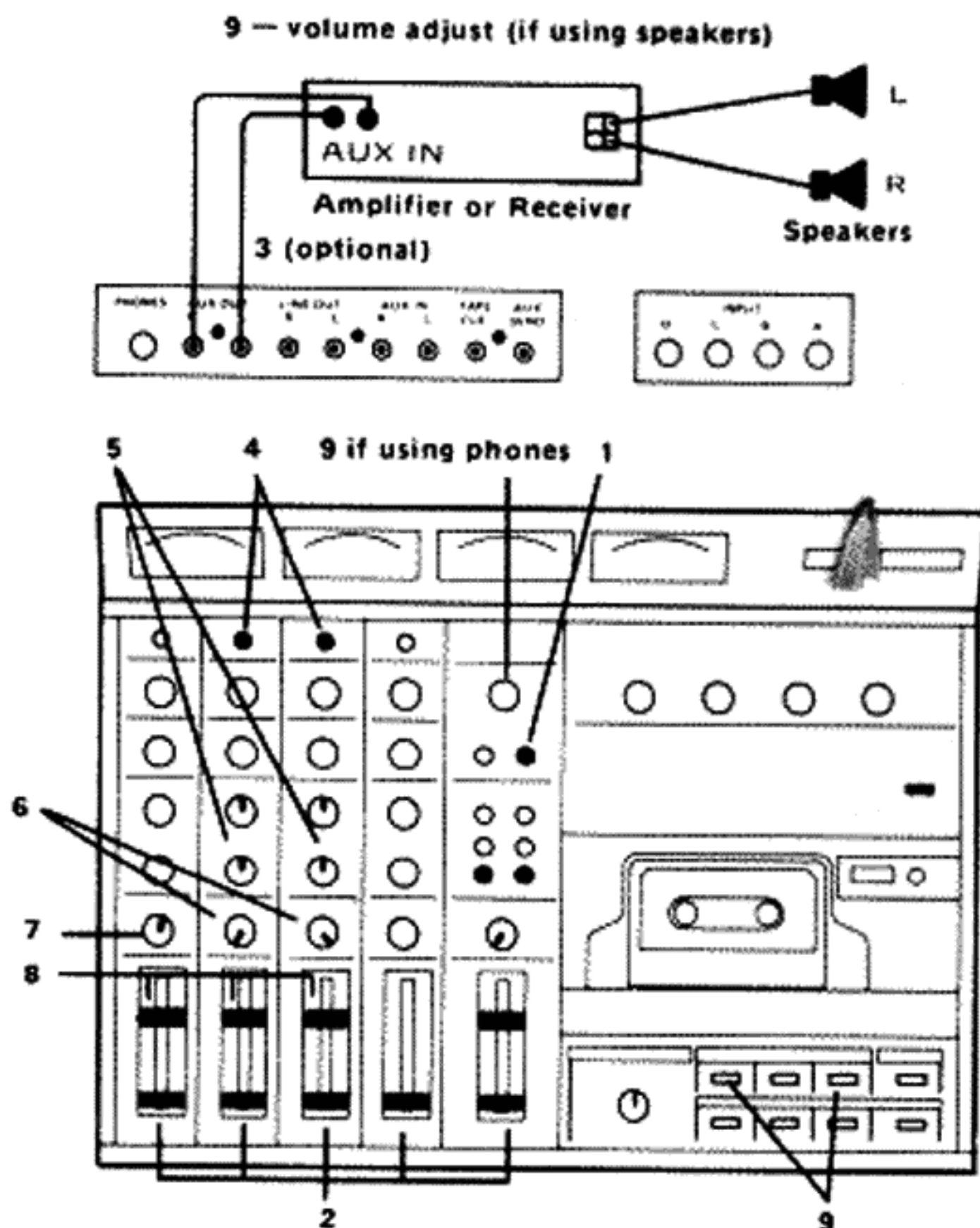

Figure 16 - Typical Setup for Stereo Playback to Evaluate Cassette

1. Press the Remix button to obtain stereo monitoring.

2. Set all the channel faders and the L-Master-R

SECTION 8 AUXILIARY SIGNAL PROCESSING

Auxiliary signal processing refers to the use of external equipment such as an echo unit, a reverb, a delay line, a phaser, a graphic or parametric equalizer, a compressor, and so forth. Such devices may be used when recording basic tracks, as part of an overdub, and/or during the remix. Basically, any device which is meant for use with an electric guitar or similar instrument, or with a microphone, can be connected between that device and the Portastudio's input; in this instance the auxiliary device is treated as an integral part of the input signal and no special Portastudio connections or adjustments are involved. Devices which are designed for operation in medium line-level circuits may be connected between the Portastudio's Aux Send jack and its Aux In jacks, between the Aux Send jack and a channel Mic/Line input jack, or between the Tape Cue jack and the Aux In jacks, as shown in the following diagrams.

NOTE: It is important to use equipment that is compatible with the levels and impedances of the Portastudio (see Section 12).

You can use either of two Portastudio output jacks, Aux Send or Tape Cue, to feed an auxiliary signal processing device. The choice depends on the specific mixing requirements, as described below:

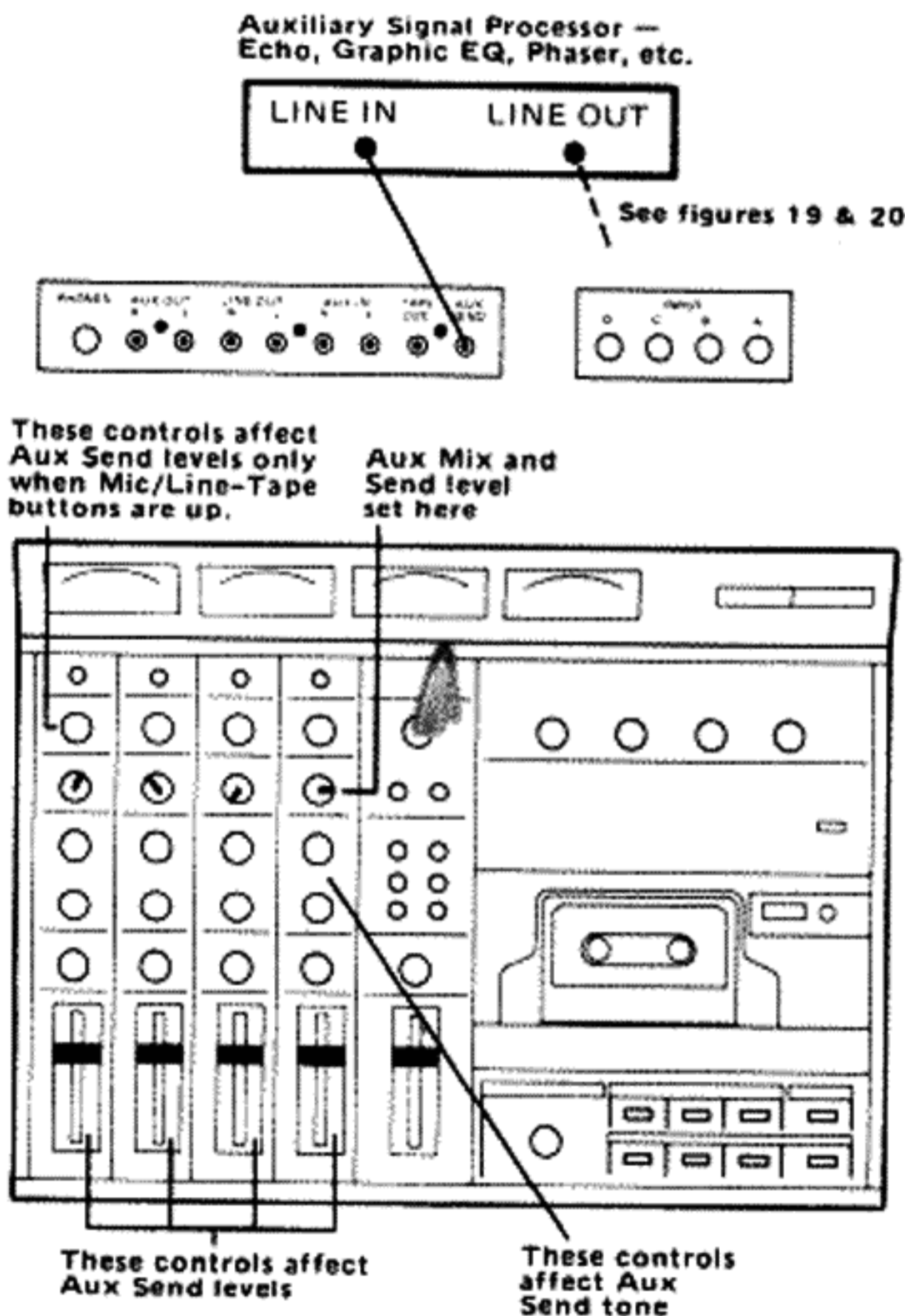

Figure 17 - Using the Aux Send Output for Auxiliary Signal Processing

a. For signal processing while recording basic tracks or an overdub, or during the remix, use the Aux Send output jack. The Aux Send control on each input channel actually "sends"

the channel's signal to a combining amplifier (a summing amplifier), where the four input channels' Aux Sends are mixed to mono for feed to the device. This Aux Send feed is post-EQ and post-fader which means that level adjustments made with the channel fader and tone adjustments made with the channel Bass and Treble controls affect the Aux Send signal. Thus, if you bring down a channel fader to reduce the input's direct contribution to the program mixing network, you simultaneously reduce the channel's contribution to the auxiliary signal processing device. Fade out a channel, and you have faded out the aux effect as well.

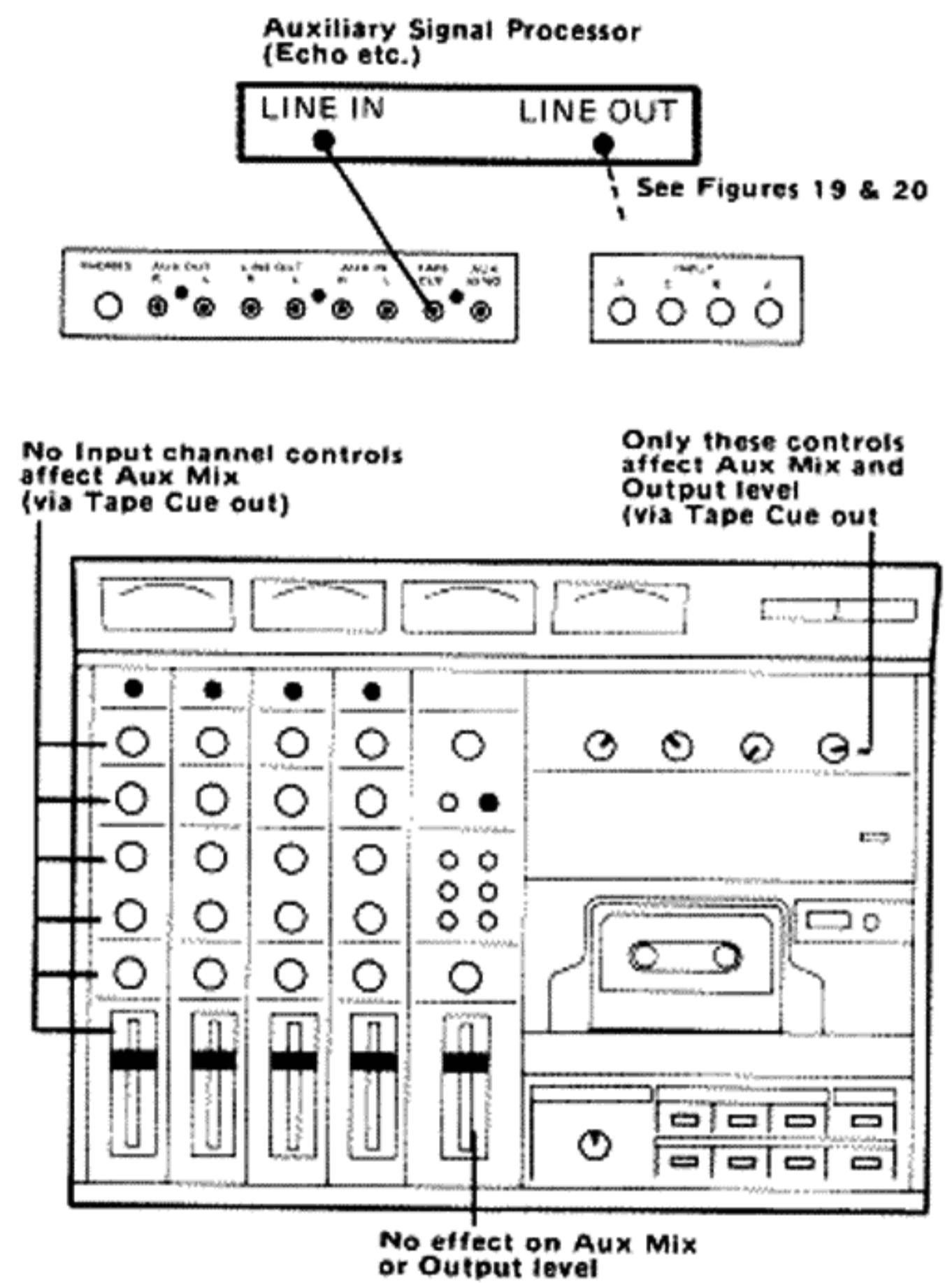

Figure 18 - Using the Tape Cue Jack for Auxiliary Signal Processing

b. An alternative aux feed may be used for signal processing during remix — the Tape Cue jack. If the Portastudio is in *Remix* mode, with the input channels' Mic/Line-Tape switches in *Tape* position, then the headphone (or speaker) monitoring does not require use of the Tape Cue level controls. Thus, these controls may be used to make a mono mix of the tracks being played back, and that mix may be fed to the auxiliary signal processor. Since the Cue feed is not subject to the input channel faders or equalizers, special effects are possible. For example, suppose the auxiliary device is an echo/reverb unit, where it can be used to provide ambience for a person

speaking on Track 1. During the program, the "direct" voice is fed to the program mix via input channel A's fader and Pan pot. The "reverberant" sound can be obtained by bringing up the #1 Tape Cue level control to pick up Track 1, feeding it via the Tape Cue R.C.A. jack to the echo/effects unit, and returning the delayed voice to the program via the Aux In jacks and the Aux Receive control. To give the effect of having the person speaking "walk away into the distance," the Channel 1 fader is brought down. This removes the "direct" sound from the program. At the same time, the Aux Receive control may be advanced, increasing the reverberation so it sounds as though the person had walked "off mic."

The Aux Send signal, after processing, must be returned to the Portastudio and blended back into the program via one of two signal paths:

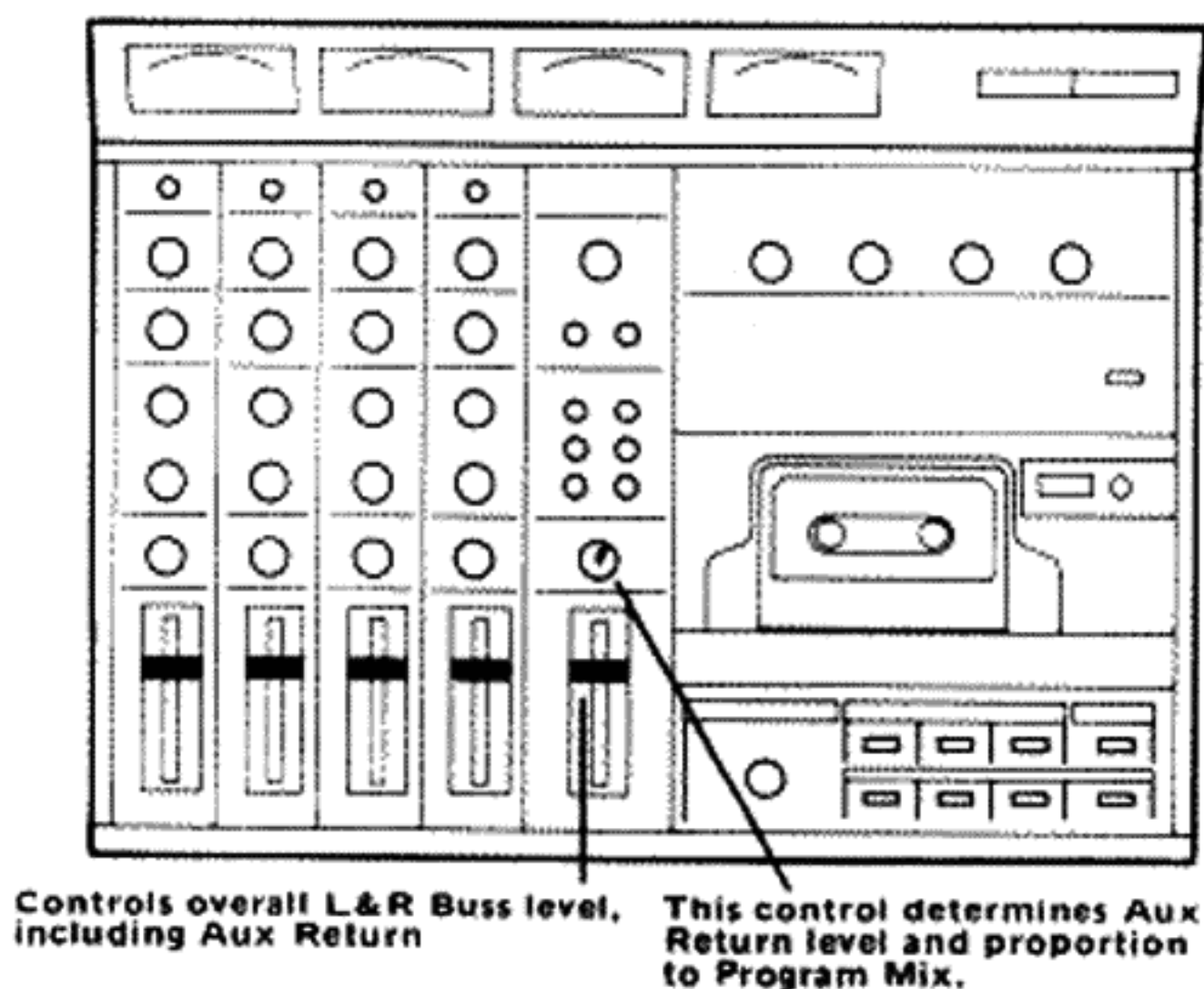
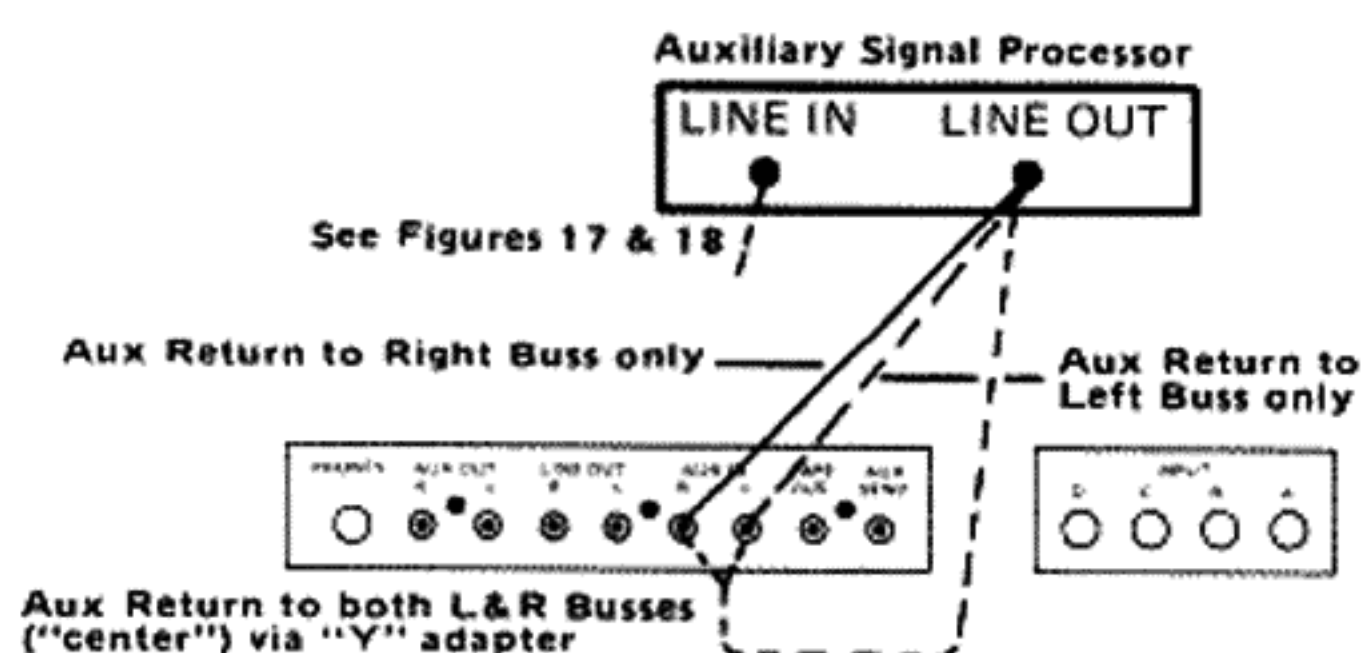
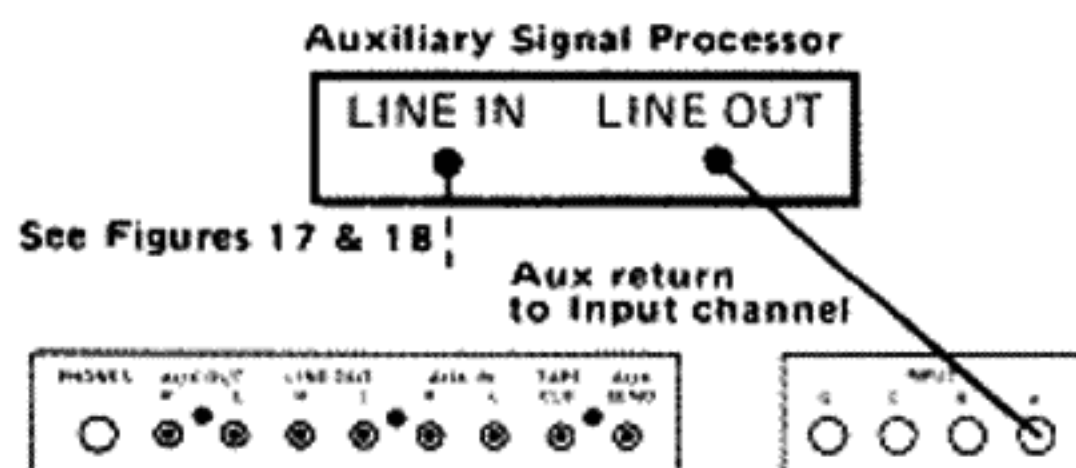

Figure 19 - Using the Aux In Jack for Auxiliary Signal Returns

a. Use the Aux In jacks. Note that even though the Aux Send is mono, there are Left and Right Aux In jacks. This allows the returning signal to be applied to either the Left or the Right Buss — or to both Busses simultaneously via a "Y" adaptor (for a "center" return). The amount of Aux In Left and/or Right signal actually applied to the program is then determined by the setting of the Aux Receive control, as well as by the L-Master-R fader.



CAUTION: Send must be at "0" on channel to which Aux is returned

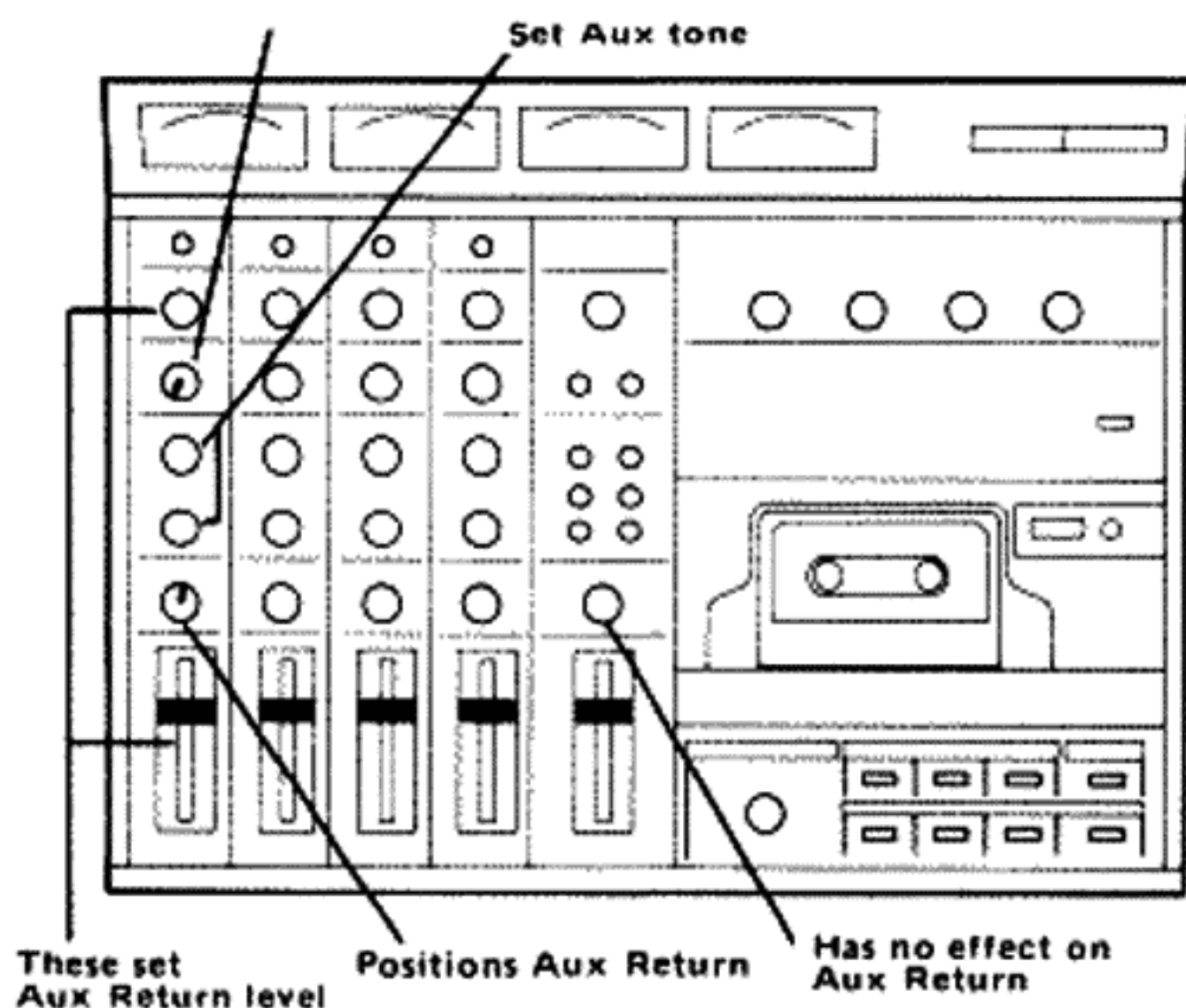

Figure 20 - Using a Channel Input Jack for Auxiliary Signal Return

b. Use a channel input, so long as one is available. The main advantage to this technique is that the returning Aux signal can be equalized before mixing it back into the program, and it can be panned anywhere between the Left and Right Busses. In addition, the channel Trim control enables the input sensitivity to be increased so that auxiliary devices with lower-level outputs may be used. In this setup, the channel fader and L-Master-R fader set the level of the returning Aux signal, and the Aux Receive control is not used.

CAUTION: If you return the Aux signal to an input channel instead of the Aux In jack(s), KEEP THE AUX SEND CONTROL ON THAT CHANNEL "CLOSED" (set at #0). Otherwise a "loop" will be created and the signal will feed back, causing a howl and possibly damaging your equipment.

SECTION 9 PUNCH-IN RECORDING DURING AN OVERDUB

What happens when a track is perfect except for one mistake in the middle? Do you have to redo the whole track to fix one small error? No, you can use a technique known as "punch-in" to fix the problem. The procedure for a punch-in (an insert) is similar to that for a normal overdub, with one major difference: punch-in inserts new material on an existing track (necessarily erasing the corresponding segment of old material), whereas a conventional overdub records new material on a different track.

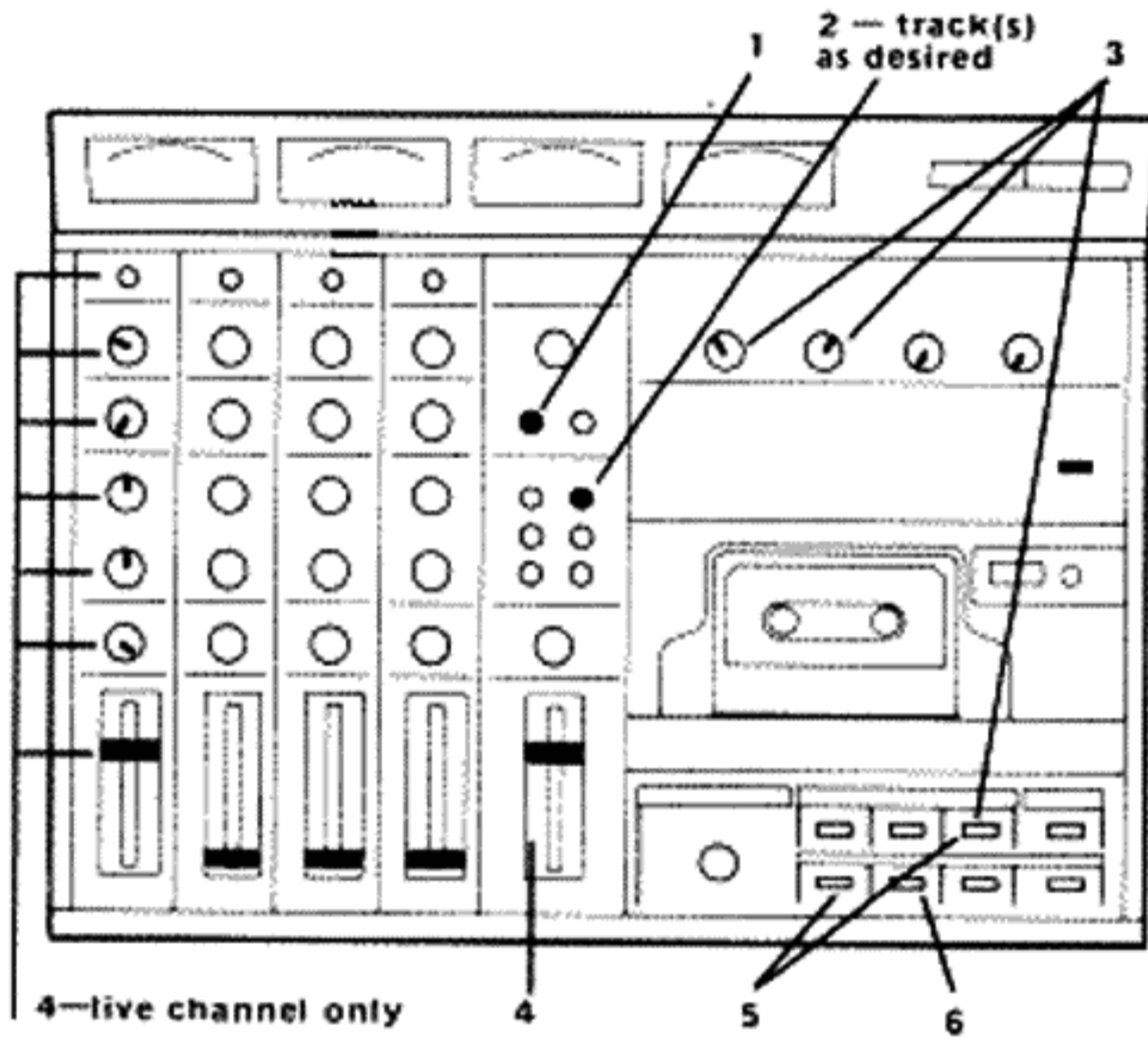

Figure 21 - Typical Setup for Punch-In Recording

1. Place the unit in *cue* mode by pressing the Cue button

2. Place the Portastudio in *record ready* mode by pressing down the Record Selector button(s) which corresponds to the track(s) on which you wish to make the insert.

3. Press the Play button and adjust the Tape Cue level controls for the desired headphone balance on existing tracks.

4. On the "live" input channel you will be using to do the insert, set the Mic/Line-Tape switch to *Mic/Line* mode, and adjust the Trim, channel fader, EQ and pan controls (and the L-Master-R Fader) as required, according to the standard procedures outlined elsewhere in this manual. The faders should be set at #0 on any channels not being used for the insert.

5. At the desired moment for the punch-in, simultaneously press the Record and Play buttons. You will hear the "new" input sound all along, but at the moment you begin recording you will no longer be monitoring the old track(s) on which the insert is being made.

HINT: Punch in "in the clear" (during even a momentary blank spot) on the desired Track. Preferably punch in simultaneously with a drum beat or percussive sound on any of the other tracks.

CAUTION: Even though it is possible to set the transport section in *record ready* mode and start recording by pressing a button in the Record Select matrix, this is not a recommended procedure because it will be more likely to "click." Use the more awkward but safer 2-button method, pushing Play and Record together after starting the playback by pushing Play alone.

6. To exit from the punch-in, press Stop. If you wish to do another punch-in further along on the same tape, use fast forward or play mode to get to that spot and repeat the above procedure. Remember that a punch-in erases the material that is recorded on the segment of the tape where the insert is made. There is no way to "layer" a new program directly on top of a previously recorded one without going to another track. In that case, the original track is played back, mixed together with the new signal, and re-recorded on another track in a process known as a "ping pong" (see Section 5).

SECTION 10 AN ALTERNATIVE CUE SYSTEM — USE ONE BUSS (L OR R)

To hear previously recorded tracks in your headphones when you are doing an overdub, you normally place the Portastudio in *cue* mode and use the Tape Cue level controls. There is an alternative method which can be used when only one new track at a time is being recorded. In this instance you feed either the Buss L or Buss R to the tape, and use the other Buss for playback of already-recorded tracks via the input channel. One advantage to this technique is that the playback can be equalized. While you can leave the Portastudio in *cue* mode for center-mono headphone monitoring, you may prefer to place the Portastudio in *remix* mode, thereby using the stereo headphone monitoring to distinguish the existing tracks from the "new" input (they will be heard in different sides of the headphones). You can return the signal from an echo/reverb unit to the Aux In of the Buss which is not being used to record, thus making it possible to hear echo in the headphone monitor without actually recording it (i.e., a "wet" monitor but a "dry" recording).

the "new" sound in accordance with standard procedure outlined in Section 1.

6. Pan the "new" sound(s) fully to whichever Buss is assigned for recording (i.e., if you are recording on Track 1 or 3, pan that input fully Left; for Track 2 or 4, pan the input fully Right).

7. Pan the input channels which are playing back the existing tracks fully to the other Buss (i.e., to the opposite side, Left or Right, from the "new" sound).

NOTE: The Pan controls must be completely clockwise or counterclockwise. Remember that the cue mix is assigned to the opposite side (Left Buss or Right Buss) from the track which is to be overdubbed. If an existing track is panned somewhere in between, part of it will "print" along with the new track, creating an inadvertent "ping-pong."

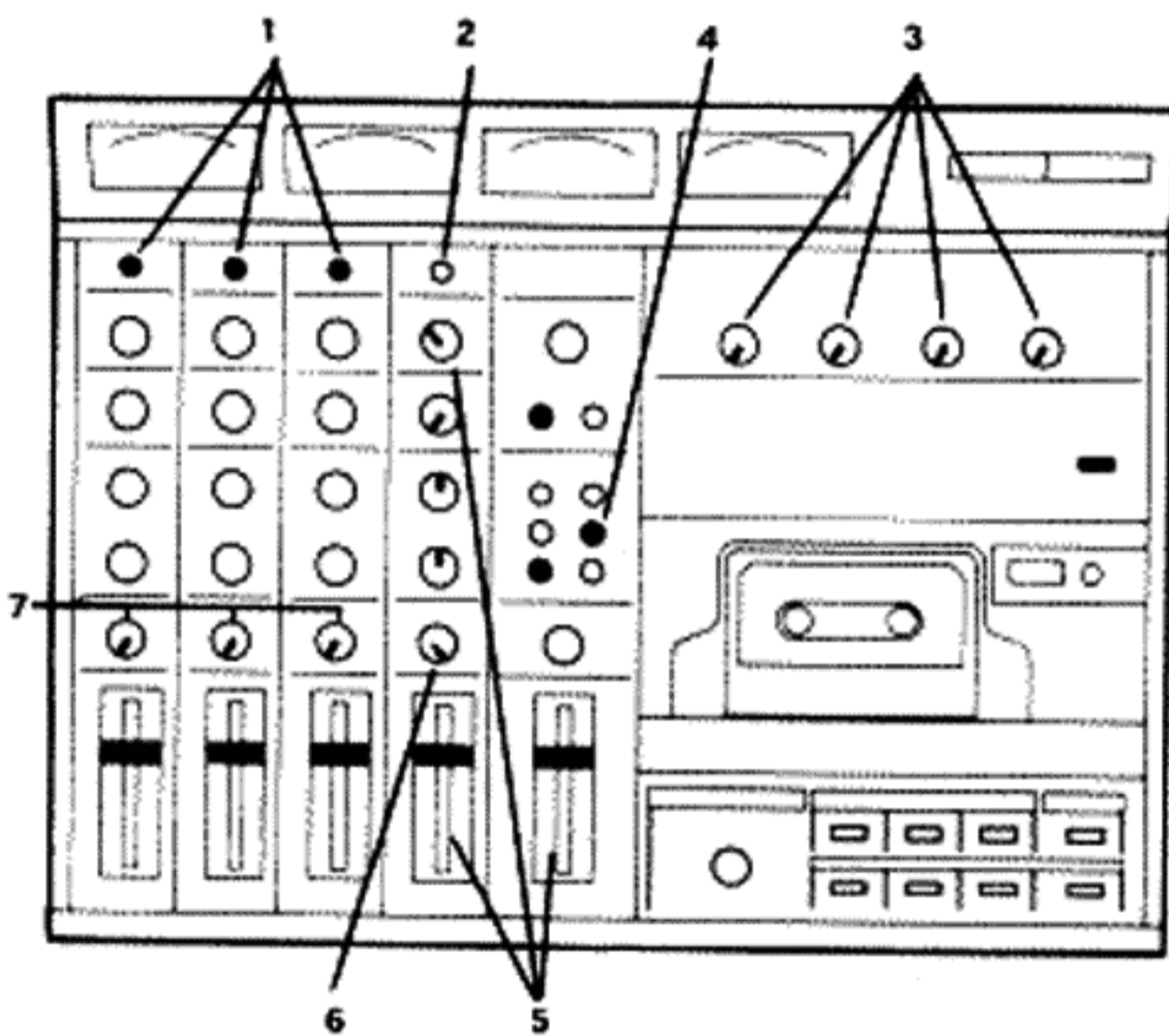

Assume existing recording on track 1, 2 and 3

Figure 22 - How to do a Cue Mix Using a Left or Right Buss

1. Place the input channels corresponding to the 1, 2 or 3 existing tracks in *Tape* mode (Mic/Line-Tape switches down).
2. Place the input channel(s) to which the new mic or line level source is connected in *Mic/Line* mode (button up).
3. Turn all the Tape Cue level controls down (#0).
4. Assign the track to be recorded by pressing down the appropriate Record Select button.
5. Set the L-Master-R fader at nominal, then adjust the channel(s) fader and Trim control for

SECTION 11

MIC PLACEMENT SELECTION VS EQUALIZATION

Before using the Portastudio's channel Equalizers (Bass and Treble tone controls) on mic signals, first try to get the sound quality as close as possible to what you want by moving the mic. Small changes in mic location or the choice of another mic can make big changes in the sound.

If possible, listen to the sound from the actual mic position. Place your head where the mic is, and listen carefully. Do you hear what you want? Or is there perhaps a different location for the mic that sounds better?

CAUTION: The "ear test" may not be wise if the volume is very high. Never put your head near any part of a set of drums. Even moderate force in playing can result in very high sound pressure, and playing "close mic" with your ear may cause permanent damage to your hearing.

In addition, it pays to try a different type of microphone. Different mics have different sound qualities, and sometimes you can get the sound you want simply by switching mics. When you have gone as far as possible without using equalization, then it's time to use the Bass and Treble controls.

HINT: Even experienced engineers have a tendency to forget that "cutting" the lows will have a similar effect to "boosting" the highs, and is much easier on the electronics (cutting leaves more headroom and consequently causes less distortion). The results are not identical but close enough to warrant trying; cut bass, raise the overall gain, and see if it sounds better than simply boosting the highs.

If you have time and a cooperative musician, experiment with different combinations of mic selection, placement and EQ settings. Although it can be very tiring for someone to play a part over and over again while you "go to school", it's the best way to get the knowledge of mic technique and tonal balance you need to make good tapes.

SECTION 12 ABOUT IMPEDANCE AND LEVEL

Impedance

WHAT IS IMPEDANCE?

All electronic parts, including cables and non-powered devices (mics, passive mixers, filters, and such) have impedance. Impedance (abbreviated "Z") is the total opposition to the flow of an AC (audio) signal, and is measured in ohms (symbol Ω). It is generally said that the output impedance of a device should be as low as possible — 100 ohms, 10 ohms, or less. This low output impedance tells you that the device offers less resistance to passage of signal, so it can feed multiple inputs (a higher load) without loss of performance or a significant drop in signal level. Conversely, the input impedance should be as high as possible — 25,000 ohms (25 kohms), 100,000 ohms (100 kohms), a million ohms (1 Megohm), or more. The high input impedance tells you that the device "uses" less of the signal applied to it (it constitutes less of a load), so the unit connected to the input is not required to deliver as much output current.

MATCHING IMPEDANCES

If the input receiving a signal has too low an input impedance, the output feeding it will be overloaded; this may cause a loss of signal level, deterioration of signal quality (distortion & noise), and in some cases damage to the equipment (burned out circuitry). For most modern audio equipment, a safe rule of thumb is that the actual input impedance of a unit should be at least 50 times the actual output impedance of the device which feeds it. (You can usually get away with an input that is only 7 times the output impedance of the device which feeds it.)

UNDERSTANDING IMPEDANCE RATINGS

The preceding would be a fairly simple rule to follow, were it not for the fact that some manufacturers rate outputs and/or inputs according to their actual impedances, and others rate outputs and/or inputs according to the impedance to which they are supposed to be connected. For example: given two identical microphone inputs, one is rated at "150 ohm mics", and the other "5,000 ohms" — why? The actual mic preamp input impedance of the device is 5,000 ohms, but it should be used with mics rated at 150 ohms. Similarly, an output impedance might be rated at "100 ohms" (this being the actual output impedance) or at "5,000 ohms" (this being the minimum recommended load impedance). A load (the input impedance into which an output is operating) is considered to be *higher* when its impedance is *lower*. Thus the statement (a) "minimum impedance = X ohms" means the same as (b) "maximum load = X ohms." In (a) the "X ohms" impedance is considered the minimum value, whereas in (b) the load of "X ohms" is considered the maximum (i.e., don't make the ohms any less than X ohms) — same thing stated differently.

THE PORTASTUDIO'S IMPEDANCE RATINGS

So much for the general concept, but what about the acceptable numbers for "matching" the impedance of outputs and inputs?

The Portastudio inputs have a very high actual impedance of 60,000 ohms (60 kohms). This means they can be fed by microphones or line-level devices having actual output impedances of from 150 ohms to about 10,000 ohms. That covers virtually all microphones, electronic instruments and other preamp-level devices.

The Portastudio outputs have actual impedances of 200 ohms, and are designed to be connected to inputs rated at 10,000 ohms (or higher) actual impedance; the exception is the Portastudio's headphone output, which can drive one or two pair of 8-ohm stereo headphones.

NOTE: For maximum clarity, we have rated Portastudio impedances two ways: "Mic/Line Impedance" refers to the maximum actual impedance of the input source, and "Input Impedance" refers to the actual impedance of the Portastudio input. Similarly, "Output Impedance" refers to the Portastudio's actual output impedance, and "Load Impedance" refers to the minimum actual input impedance of the device to which the Portastudio output is connected.

FIGURING IMPEDANCE WHEN FEEDING MULTIPLE INPUTS FROM A GIVEN OUTPUT

If one output is to be "Y" connected to two (or more) inputs, the combined load of the multiple inputs must not exceed the rated load impedance. For example, if two inputs are each rated at 10,000 ohms actual impedance, when "Y" connected they present a total load of 5,000 ohms. (Note that the total load impedance is not the sum of the two input impedances, but a lower number — the lower impedance representing a higher load, which one would expect.) To figure the load impedance of two identical inputs, divide the impedance of one in half (i.e., $10,000/2 = 5,000$). For unequal impedances, divide the smaller impedance number in half. So long as the resulting number for combined load impedance is at least 7 times the actual output impedance, the connection is OK. If you want to connect several inputs to a given output, the formula is as follows:

$$Z_T = \frac{1}{\frac{1}{Z_1} + \frac{1}{Z_2} + \frac{1}{Z_3} + \dots + \frac{1}{Z_n}}$$

Where Z_T is the total (combined) load impedance, Z_1 the impedance of the first input, Z_2 the impedance of the second input, and so forth to Z_n , the impedance of the last input.

Levels

Observe that *level* is not directly related to *impedance*; low impedance outputs can be low or high level, and high impedance outputs can be

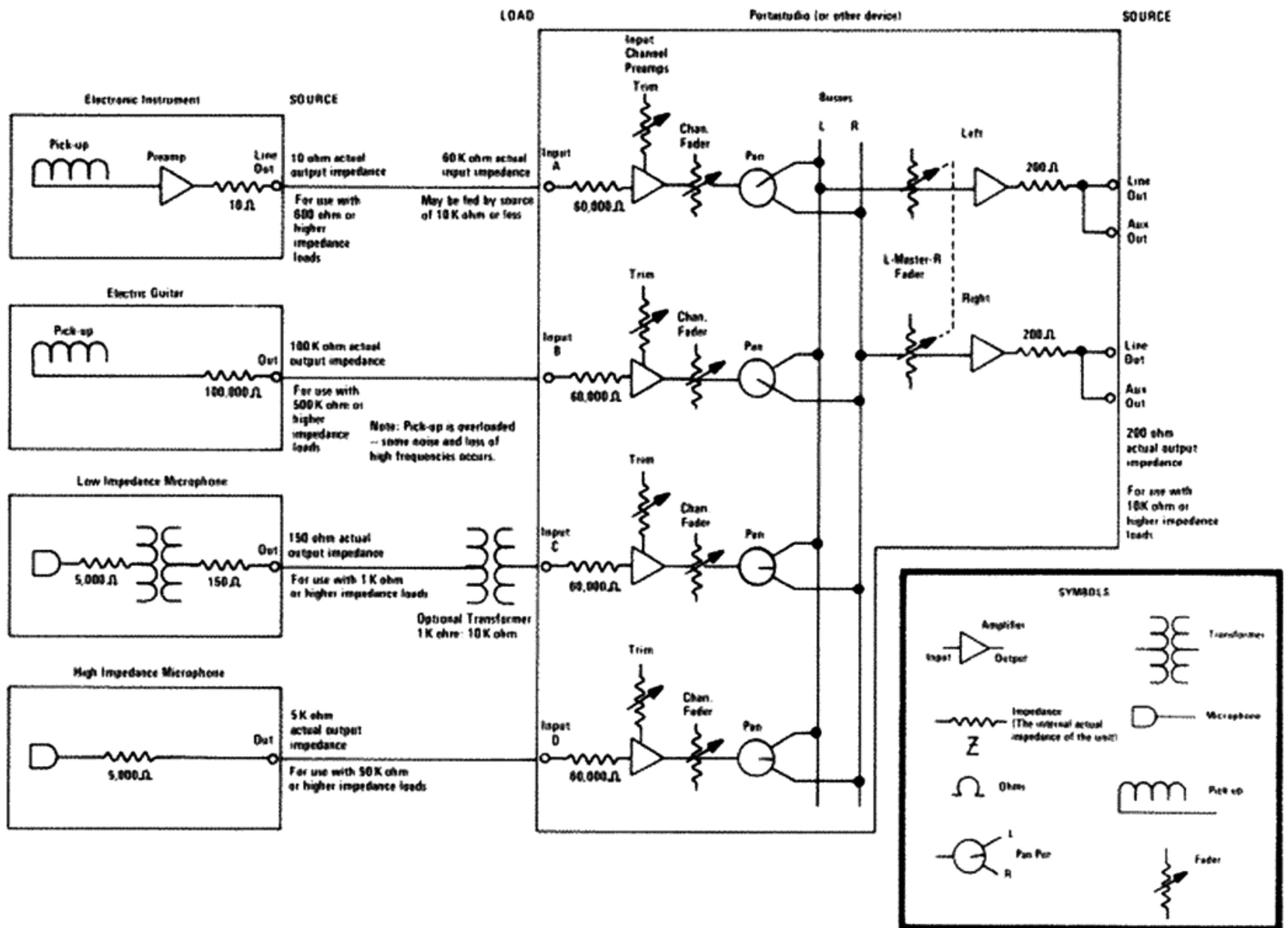

Figure 23 - Input & Output Impedance Designations

low or high level. *Nominal level* refers to the average level (or voltage) given an average volume program material and with the controls set at their "normal" or "nominal" settings. *Maximum level* refers to the peak level which can be accommodated without distortion. Levels are often expressed in dBv, where 0 dBm = 0.775 volts (775 millivolts). The VU meters on the Portastudio are calibrated as follows:

With a Buss assigned on the Record Select matrix, a 0 VU reading on the Buss L/Trk 1 or Buss R/Trk 2 meter corresponds to a Line Output level of -10 dBv (0.3 volts).

With an input channel assigned completely to either the Left or Right Buss, the channel's Mic/Line-Tape switch in *Mic/Line* mode, the channel fader at nominal (shaded zone), and the Trim control fully clockwise (toward "M"), 0 VU reading on the Buss' VU meter corresponds to an input level of -60 dBv (1 millivolt). If the Trim control is rotated fully counterclockwise (toward "L"), the 0 VU reading now corresponds to an input level of -10 dBv (0.3 V).

All you really have to know about levels and impedances is that they do matter, and you can check the Portastudio specifications in Section

14 to find out what devices are compatible. If you want to understand a little more about the "dB", read the note below.

NOTE: For those who are interested, dB describes a ratio, not an absolute number. Twice the voltage or sound pressure level, in dB, is an increase of 6 dB, and half the voltage a decrease of 6 dB. Ten times the voltage is a change of +20 dB, and 1/10 the voltage is a change of -20 dB. (Unlike voltage or sound pressure level, twice the power is +3 dB, and ten times the power is +10 dB.

Placing certain letters behind the "dB" gives the dB values a specific reference instead of a general ratio. For instance, 0 dBm = 0.775 volts, and other dBm numbers can be calculated to correspond to exact voltage values. The 0 dBV reference is 1 volt. The 0 dB SPL reference is 0.0002 dynes/square centimeter (20 micro-Pascals*). The 0 dBm reference is 1 milliwatt (which happens to be 0.775 volts only when the circuit impedance is exactly 600 ohms). The significant point is that "dB" always describes a ratio, so an increase or decrease of so many dB does not always represent the same number of volts, Watts, dynes/cm², etc.

* The Pascal is a more recent unit of Sound Pressure Level. 1 Pascal (abbreviated "Pa") is equal to 10 dynes/cm²

SECTION 13 MAINTENANCE AND SERVICE

Cleaning

Cleaning the path along which the cassette tape travels is essential to ensure continuing top quality performance. It is normal for dirt and oxide to accumulate on the parts which come in contact with the tape, due to surface shedding. If the tape lifts away from the head due to this buildup of dirt and oxide, high-frequency performance will be degraded — even a particle the thickness of a fine human hair can produce disastrously audible results. A clean tape head will not cause dropouts, so clean the unit before you begin each recording, overdubbing or remixing session — or every 4 hours of operation.

CAUTION: NEVER USE LACQUER THINNER, SPIRITS, MEK OR OTHER SOLVENTS ON THE TAPE HEADS. Denatured alcohol is an acceptable cleaning agent for metal parts, but NOT RUBBING ALCOHOL (which contains unwanted water and oils, and will leave a residue). Also, never touch the heads with any metal or abrasive object. The pinch roller should be cleaned with rubber cleaner, but BE CAREFUL NOT TO SPILL ANY CLEANER ON THE PORTASTUDIO as this may damage the finish.

We recommend using a TEAC Recorder Maintenance Kit, which contains all the cleaning supplies you'll need.

Demagnetization (Degaussing)

A tape recorder functions by using an electric current in the heads to create a temporary electro-magnet which, in turn, magnetizes small particles embedded on the surface of the recording tape. (Typically these particles are comprised of iron oxide, cobalt oxide, or chromium dioxide.) It is normal for some of the original magnetic field, or some of the magnetism on the tape, to permanently transfer to the heads and nearby metal parts. Unfortunately, the recording can be damaged by this residual magnetism. Even relatively minute residual magnetism can partially erase a tape, especially the high frequencies. This is why demagnetization (also known as degaussing) is necessary. Care is necessary when using any demagnetizer, however, since improper operation can cause more harm than good — a strong and permanent magnetic charge can be imparted to the very items you wish to demagnetize. TEAC cannot be responsible for damage to your equipment or tapes caused by improper use of a demagnetizer, so please stick to the exact procedures listed.

CAUTION: To avoid damage to the Portastudio, ALWAYS MAKE SURE THE PORTASTUDIO POWER IS OFF before attempting demagnetization. The AC power flowing through a demagnetizer would appear to the heads as a 10,000 VU audio signal (at 60 Hz), and could seriously damage the electronics. Also, NEVER TURN ON OR TURN OFF THE POWER TO THE DEMAGNETIZER UNLESS IT IS AT LEAST 3 FEET (1 METER) AWAY FROM THE PORTASTUDIO. To do so would create a strong electric current surge, a correspondingly strong magnetic field, and possibly place a permanent magnetic charge on parts of the recorder that would be too strong to be removed by subsequent demagnetization.

DEMAGNETIZATION PROCEDURE

1. Turn OFF the Portastudio's AC power switch, open the cassette door, and remove the cassette if one is present.

2. Making sure it is at least 3 feet away from the Portastudio, turn ON the demagnetizer.

3. SLOWLY move the demagnetizer in toward the tape path until the tip is within 1/8-inch of the heads.

4. SLOWLY move the demagnetizer up and down, in close proximity to all metal parts in the tape path (heads, guides, cassette locating pins, etc.), but DO NOT TOUCH THE PARTS.

5. SLOWLY move the demagnetizer at least 3 feet away from the Portastudio and then turn OFF (or unplug) the demagnetizer.

NOTE: We suggest you concentrate when using a demagnetizer. Do the job at hand, and avoid engaging in conversation. While the device is not dangerous to you, it can damage your recorder if it is accidentally turned On or Off or if the power cord is disconnected when the demagnetizer is near the recorder. Like any powerful tool, when used improperly the demagnetizer can do more harm than good; used properly, the demagnetizer will improve the performance of your recorder and will help preserve your tapes.

The tasks of cleaning and demagnetization may be tedious, but persist. Do them regularly and carefully, and your efforts will be rewarded with better sounding recordings.

Service

Since the Portastudio is a complex device, it is possible that some apparent malfunctions may actually be due to incorrect control settings or hookups. Experience and a careful reading of this manual should help, along with the troubleshooting chart below. In the event of a genuine mechanical or electronic failure, see the Warranty card which came with your unit, or contact the factory for more information. DO NOT RETURN YOUR PORTASTUDIO TO TEAC, EVEN IF IT IS FOR WARRANTY SERVICE, UNLESS YOU FIRST RECEIVE SPECIFIC AUTHORIZATION FROM THE FACTORY.

Troubleshooting Chart

DIFFICULTY	POSSIBLE CAUSE
Signal did not "print" (no program recorded when you expected it)	<ol style="list-style-type: none"> 1. Pan control rotated toward the wrong buss (i.e., you engaged Record Select 1 but panned signal to the Right Buss). 2. Record Select button not engaged.
Unsatisfactory Mix in the Headphones	<ol style="list-style-type: none"> 1. Check Remix and Cue buttons. 2. Check Tape Cue level controls. 3. Check Buss/Monitor control, input faders and Master fader.
No VU meter deflection with signal applied to channel input jack(s)	<ol style="list-style-type: none"> 1. Check Mic/Line-Tape switch. 2. Check Trim control and fader on the input, and Master fader. 3. Check Record Select buttons. 4. Check for damaged input cables, connectors, mic, etc. 5. If one "bad" channel is suspected, try using a different input channel.
Distorted signal coming into input channel	<ol style="list-style-type: none"> 1. Check Trim control, channel fader and Master fader. 2. Check for impedance or level mismatch.
Distorted signal coming into Aux In jack(s)	<ol style="list-style-type: none"> 1. Check Aux Receive control and Master fader setting. 2. Check for impedance or level mismatch.
Inadvertent ping-pong	<ol style="list-style-type: none"> 1. Pan control rotated toward incorrect Buss (or somewhere between the Left and Right Busses). 2. An "unwanted" input channel's Mic/Line-Tape switch is in "tape" mode and the channel fader is up.
Poor fidelity when playing back Portastudio tapes	<ol style="list-style-type: none"> 1. Transport is dirty or magnetized (perform maintenance procedures). 2. Incorrect type of recording tape was used, or tape is worn out. 3. Impedance or level mismatch between Portastudio and input sources, or Portastudio and monitor amplifier.
Copy (dub) doesn't sound like Portastudio Remix	<ol style="list-style-type: none"> 1. Incorrect procedure used during the mixdown. 2. Dubbing recorder incorrectly aligned, dirty, magnetized, or in need of service. 3. Wrong tape used on dubbing recorder. 4. Portastudio dirty or magnetized.

THE PORTASTUDIO: FROM INPUT TO REMIX

The block diagram shows the actual wiring sequence of all the significant parts, and indicates all the possible signal pathways in and out. Understanding the wiring sequence is the key to understanding the Portastudio. Some parts of the Portastudio don't show up on the outside as do the labeled controls and connectors, but they do appear on the block diagram (representing circuits within the unit). A key to the symbols is shown on the diagram itself. Generally, signals flow from Left to Right, although the mixing network which feeds the Dolby Circuit/Record Select Matrix area is an exception. The diagram may appear less confusing when you realize that all 4 input channels are identical, differing only by the input connector and the Track from which they derive a signal. Similarly, observe that the four Record amplifiers are identical, and the four Reproduce (Playback) amplifiers are identical.

If you "follow" the signal through one input channel, onto one of the two program mixing Busses (Left or Right), through the Record Select switch matrix, through one Record Amplifier and into one track of the record/play head, you will understand how any of the input channel signals can get recorded onto the cassette tape. If you "follow" the pickup of a previously taped signal from one track of the same Record/Play head through a Reproduce amp, into the "Tape" side of a Mic-Line/Tape switch, you can see how a transfer or remix is accomplished. If you follow that same signal from the Reproduce amp to the corresponding Tape Cue level control, to the headphone amplifier circuitry, you will see how the Cue switch provides a mono blend of off-the-tape signals. Observe also that the L-Master-R fader and the Buss Output Amplifiers together feed the stereo program mix to several places, including the Buss/Monitor control, so the stereo mix can be fed into the headphones at a level which differs from that set with the L-Master-R fader. Observe also that when the Cue switch is engaged the Buss/Monitor control's Left and Right signals are combined to mono. When the Remix switch is engaged, the same signals from the Buss/Monitor control are fed to the Left and Right sides of the headphone output, while the Tape Cue controls no longer feed the headphones.

Although it may seem foreign at first, we recommend you study this block diagram. You may find it of real value to flip out this page so the block diagram remains in view as you read the rest of the manual. Once you learn to follow the diagram, you will be able to anticipate how a certain control will work or where a signal will flow — even before you try the setup. You don't have to understand a block diagram in order to make good recordings, but the more familiar you become with the Portastudio, the more creative freedom you achieve.

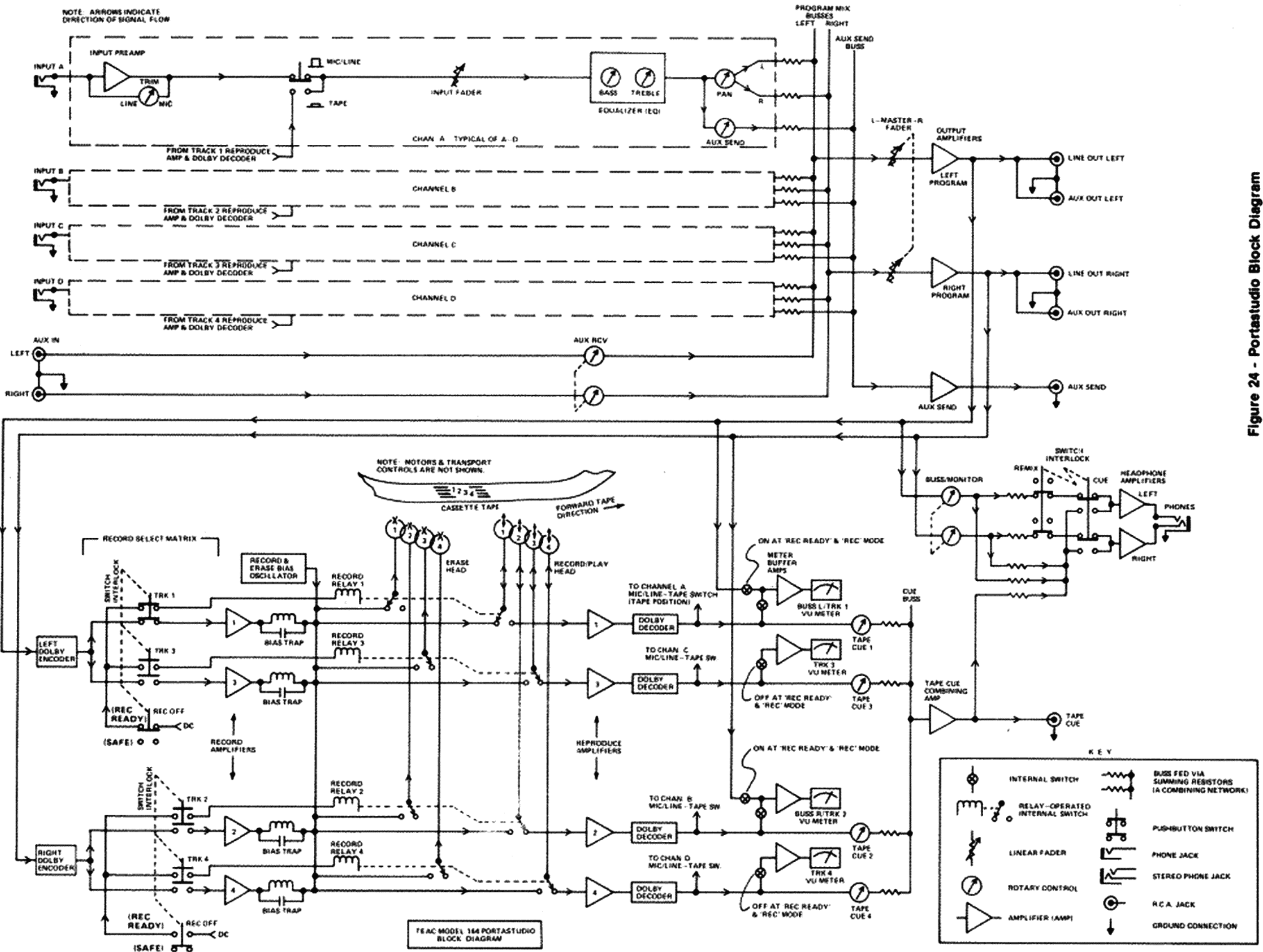

Figure 24 - Portastudio Block Diagram

SECTION 14 SPECIFICATIONS

MIC/LINE INPUT (x4)

Mic or Line Impedance: 10 kohms or less
Input Impedance: 60 kohms
Nominal Input Level: MIC -60 dBv (1 mV);
LINE -10dBv (0.3 V)
Minimum Input Level: -66 dBv (0.5mV)
Maximum Input Level: +8 dBv (2.5 V)

AUX INPUT (x2)

Input Impedance: 65 kohms
Nominal Input Level: -10 dBv (0.3 V)

LINE OUTPUT (x2), AUX OUT (x2)

Output Impedance: 200 ohms
Load Impedance: 10 kohms or higher
Nominal Output Level: -10 dBv (0.3 V)
Maximum Output Level: +15 dBv (5.6 V)

HEADPHONE OUTPUT (Stereo)

Load Impedance: 8 ohms or higher
Maximum Output: 100 mW @ 8 ohms

STONE CONTROLS

Treble: Variable ± 10 dB @ 10 kHz
Bass: Variable ± 10 dB @ 100 Hz

RECORDING TAPE: Compact cassette, C-60 or C-90 - use a gamma-ferric oxide tape that requires high-bias level (chrome position) and 70-microsecond EQ (TDK-SA, MAXELL UDXL-II, or equivalent).

RECORD TRACKS: 4-track, one direction (Special format)

RECORD CHANNELS (Electronics): 2 with full-time Dolby NR encoding (switchable to the 4 record tracks)

PLAYBACK CHANNELS: 4 with full-time Dolby NR decoding

NORMAL TAPE SPEED: 3 $\frac{1}{2}$ ips $\pm 1\%$

PITCH CONTROL (VSO): $\pm 15\%$ of normal tape speed

RECORDING TIME: 15 minutes for C-60

HEADS: 4-channel erase (ferrite/permalloy);
4-channel record/playback (permalloy)

MOTORS: 1 FG Servo-controlled DC capstan motor and 1 DC reel motor

WOW & FLUTTER: $\pm 0.06\%$ peak, weighted; 0.04% RMS, weighted (measured with flutter test tape)

FAST WIND TIME: 70 seconds for C-60

FREQUENCY RESPONSE

Mixer Section: 20 Hz - 20,000 Hz
Recorder Section: 20 Hz - 18,000 Hz (40 Hz - 12,500 Hz
 ± 3 dB @ 0 VU)

TOTAL HARMONIC DISTORTION

Mixer Section: 0.3% @ 1,000 Hz, nominal level
Recorder Section: 2% @ 315 Hz, 0 VU (overall)

SIGNAL-TO-NOISE RATIO

Mixer Section: 68 dB weighted, mic in to line out (any channel)
Recorder Section: 63 dB, weighted (ref. to 315 Hz, 250 nano-webers per meter)

CROSSTALK

Mixer Section: 65 dB @ 1,000 Hz
Recorder Section: 50 dB @ 1,000 Hz

ERASURE: 65 dB @ 1,000 Hz

POWER REQUIREMENTS: 120 V AC, 60 Hz, 28 Watts

(USA/CANADA Model)
220 V AC, 50 Hz, 28 Watts (Europe Model)
240 V AC, 50 Hz, 28 Watts (U.K./Australia Model)
100/117/220/240 V AC, 50/60 Hz, 28 Watts
(General Export Model)

DIMENSIONS: 46 x 12 x 37 cm, (18-1/8 x 4-3/4 x 14-5/8 in.)

WEIGHT: Net, 9 kg (20 lb); Shipping, 10 kg (22 lb)

Specifications subject to change without notice or obligation.

TEAC.

TEAC CORPORATION 3-7-3, NAKA-CHO, MUSASHINO, TOKYO PHONE: (0422) 53-1111

TEAC CORPORATION OF AMERICA, 7733 TELEGRAPH ROAD, MONTEBELLO, CALIFORNIA 90640 PHONE: (213) 726-0303

57000034001

PRINTED IN JAPAN 0680U1.5-D-3297E